

Volvo Construction Equipment
Building Tomorrow



EWRI30E

Volvo Wheeled Excavators 12.9-14.4 t / 28,440-31,747 lb 121 hp





WELCOME TO OUR WORLD

Welcome to a world of industry leading machinery. A world where imagination, hard work and technological innovation will lead the way towards developing a future which is cleaner, smarter, and more connected. A world supported by the enduring values of the Volvo Group. A world of stability, sustainability and innovation. A world which we put our customers at the heart of.

Welcome to the world of Volvo Construction Equipment – we think you're going to like it here.

Working harder, working smarter

For over 180 years Volvo has been a pioneer in the design and manufacture of machines which set the standard for efficiency, performance and uptime. Across our range of excavators, wheel loaders and haulers, our reputation for engineering excellence is unrivalled, which means whatever your operation or application, we can provide a total fleet solution to help you succeed.

Building on our proud history, the Volvo Concept Lab continues to create cutting-edge ideas and innovative concepts, to ensure we offer customers machines which work harder and smarter long into the future.

Solutions for you

Our industry leading machines are just the start of your relationship with Volvo. As your partner, we have developed an extensive range of additional solutions to help you improve uptime, boost productivity and reduce costs.

Designed for your business

Structured across nine blocks, our portfolio of products and services are designed to complement your machine's performance and boost your profitability. Simply put, we offer some of the best guarantees, warranties and technological solutions in the industry today.

There when you need us

Whether you're buying new or used, our global network of dealers and technicians offer around-the-clock support, including machine monitoring and world-class parts availability. It's the basis of everything offered by Volvo Services, so you can be confident we've got you covered right from the start.



BUILDING TOMORROW

Top of the class

The EWR130E wheeled excavator is designed to set new standards in the market when it comes to powerful machine performance in an unbeatably compact package. This multipurpose 12-13 t machine can work in tight urban spaces, move quickly through infrastructure projects, and has a light enough footprint for landscaping. Wherever you are working, count on the EWR130E to help your project succeed.

Unrivalled lifting capacity

The EWR130E boasts a considerably lower center of gravity compared to equivalent machines, resulting in unbeatable stability. The standard, two-piece boom enables lifting up to 4.3 t (9,480 lb) at 6 meter (19.7 ft) reach. This smartly designed digging equipment, combined with powerful 90 kW (121 hp) Volvo engine, delivers best in class breakout and tear-out forces.



Additional compactness

Enhance machine versatility with the in-line outriggers. This option allows the machine to be positioned and stabilized in the most compact of working areas.



Made to maneuver

Increase machine flexibility with a choice of three steering modes, easily selected from the cab using the rotary switch. The optional 4-wheel steering system reduces the turning radius.

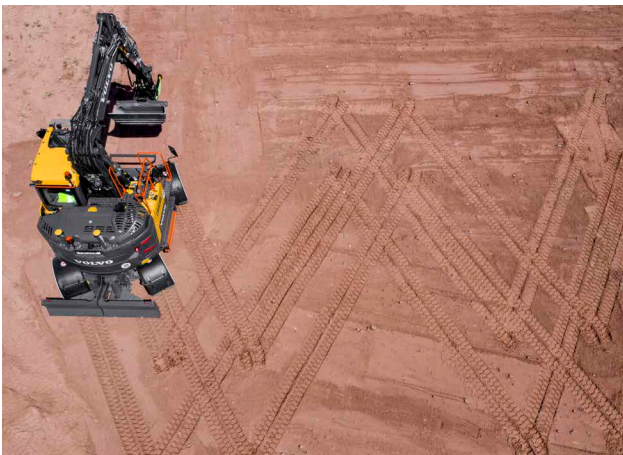

Divided blades

Additional divided blades create opportunities for the operator to level the machine in a wider variety of locations such as sidewalks and uneven ground.





THE COMPACT CHOICE

Take on jobs that a conventional excavator cannot with the EWR130E. With a new boom and arm design, the machine features the shortest rear (1.55m / 5' 1") and front (1.81m / 5' 11") swing radius on the market, providing enhanced safety and comfort when working in confined spaces. A low machine height, combined with optimized tie-down points on the lower frame, makes easy work of machine transportation.



DESIGNED BY YOU, BUILT BY VOLVO

At Volvo, we go the extra mile to make sure our customers are included throughout the entire engineering journey of our machines. On-site demonstrations and test drives are fundamentals to each milestone of the development; We give customers the opportunity to tailor their machine to the demands of their jobsites. Rigorously tested, the EWR130E is designed to achieve outstanding results in even the most demanding conditions.

Built in partnership

To make sure our machines reflect what the market needs, we involve customers at every stage of development. The EWR130E is built on the success of its bigger brother, the EWR150E. Based on feedback from the field, we came up with a design that exceeds expectations and takes short tail swing excavators to the next stage.

Safe, from the inside and out

Find your way easily when entering and exiting the machine, thanks to bright steps and handrails. As an option, the welcome light can be controlled remotely, to guide you in darkness. Our range of LED work light packages provide further visibility when working in low-light conditions.

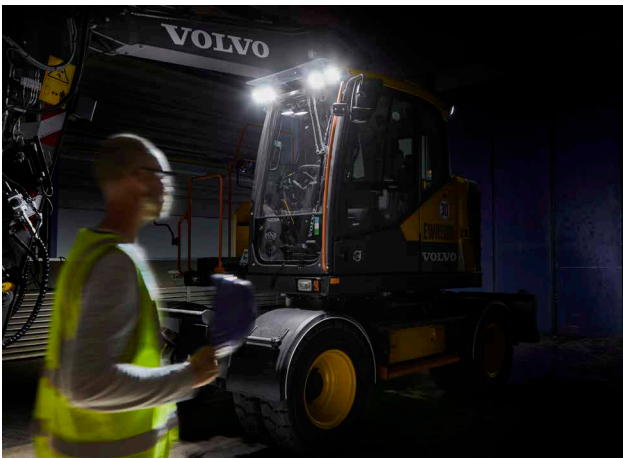

Clean and productive

When travelling at high speeds, the optional axle mounted mudguards will keep your machine cleaner for longer thanks to a large surface area following the wheel arch.



Easy attachments setup

Easily program attachment pressure and flow, without the need of a service technician, thanks to the Attachment Management System. Our system can store the settings of up to 32 different attachments, helping to reduce downtime and keep costs to a minimum. A shortcut button on the console provides quick access to the attachments menu.



Bring your tools

Perfect for transporting tools and lifting chains, an ergonomically positioned drawer-type toolbox conveniently slides out from the undercarriage. First introduced by Volvo, the toolbox can carry up to 120 kg (265 lb). Box dividers, which can be adjusted into five different positions, help the operator stay organized.



The operator's choice

While the machine may be compact, the EWR130E cab is the same as on the larger wheeled excavators, delivering all the spaciousness and all-around visibility you would expect from Volvo. A convenient cab layout, ergonomic controls and outstanding level of comfort provide an unrivalled operator environment.

Volvo Smart View

Operators can work in complete confidence thanks to optional Volvo Smart View. The system uses front, rear and side cameras to provide a real-time, overhead view of the machine during operation on the color monitor. The result is safer machine rotation while working, especially in confined spaces.



Operator convenience

The EWR130E boasts the same full-size cab as its larger counterparts, providing operators with a spacious and low-noise working environment. Ergonomic and easy-to-use controls include programmable buttons on the joystick, allowing operators to keep the most relevant functions at hand during the working day.

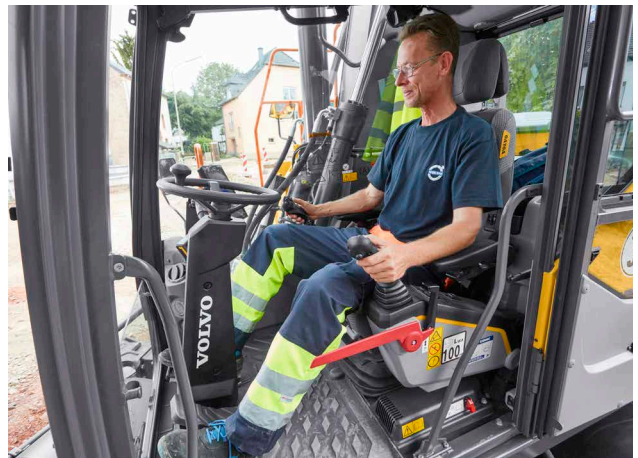

Drive in comfort

For easy operation and reduced operator fatigue, Comfort Drive Control gives operators the opportunity to steer the machine without needing to take their hands off the joystick, at speeds up to 20km/h (12 mph). A single joystick can handle almost every operation – from wheel steering, to blade and outrigger control, windshield wiping and more.



Fully adjustable joystick

Find the perfect position of your L8 joystick thanks to a special ball joint allowing the joystick to be fully adjustable to any angle. Operators can adjust the angle to a neutral position in seconds, for enhanced operator comfort and reduced strain.

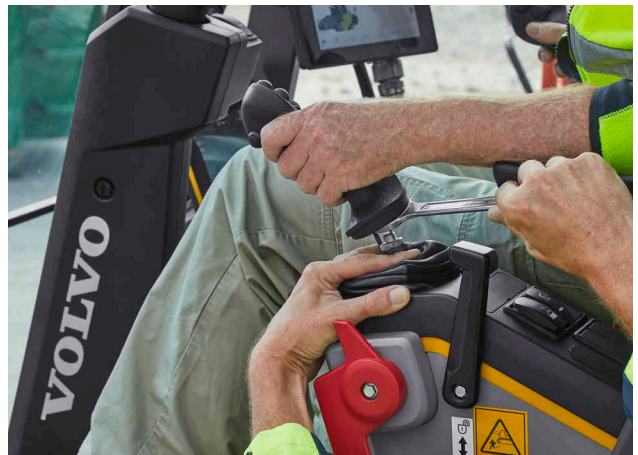



SEE THE DIFFERENCE

Operators enjoy an unobstructed 360-degree view around the machine in the EWR130E. The low superstructure and intelligent design of the counterweight, hood and doors enhances visibility to the rear of the machine. Visibility to the right of the machine is also best-in-class due to no parts positioned on the right-hand side of the machine, a design concept unique to Volvo.



VERSATILE PERFORMANCE

Swiftly and easily connect hydraulic attachments from the comfort and safety of the cab, with the Steelwrist® Auto Connect Quick Coupler.

Get the job done

A host of features including Boom Suspension System, trailer hitch, automatic digging brake as well as seamless compatibility with tiltrotators and fully hydraulic quick couplers, all combine to deliver outstanding levels of productivity.

Take on any angle

Boost productivity with the Steelwrist® tiltrotators, providing flexibility for precise construction jobs at any angle. The factory-fitted Steelwrist tiltrotator preparation system gives you the power to control both the machine and tiltrotator using the original joysticks, with the information presented on the main display.



Comfort at speed

Experience ultimate control and enhanced comfort while traveling at speeds of up to 35 km/h (22 mph). The optional Boom Suspension System automatically engages at 5km/h (3mph), absorbing shocks to reduce bouncing and bucket spillage. The hydraulic circuit, complete with accumulators, reduces shock when driving over rough terrain or bumpy roads for smoother and faster travel.



Get hitched

With the trailer hitch you can pull a trailer weighing 3 tons (6,614 lb), or up to 8tons (17,637 lb) with additional overrun brakes, perfect for transporting all required tools and equipment to the job site. The trailer hook can be fitted on the outriggers or parallel blade for optimized machine versatility.

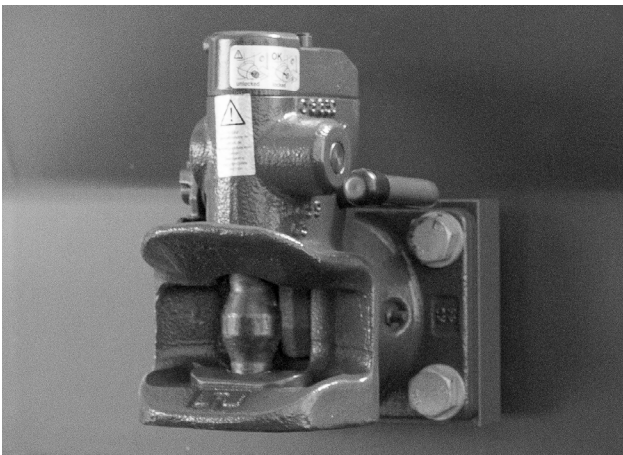

Automatic digging brake

A Volvo first, the automatic digging brake lets you get straight to work once you stop. The service brake and oscillation lock automatically engage when the machine's speed is at zero.



Boost your profits

A world-class machine is just the start of how Volvo strives to add value you to your operation. Our portfolio of attachments and support services are designed to complement your machine's performance and boost your profitability.

Dig Assist apps

Unlock the full potential of your machine's productivity with optional Dig Assist, powered by the 10" Volvo Co-Pilot display. Gain access to a set of smart apps, including On-Board Weighing, Start, In-Field Design and 3D software packages, designed to make the digging process more accurate, and faster.

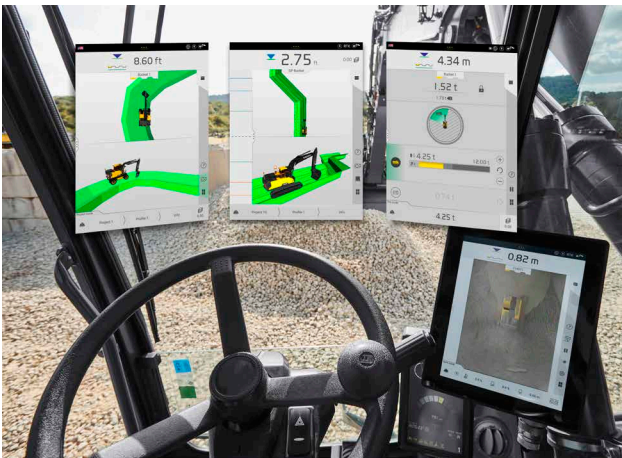

Easy machine monitoring

Make sure your Volvo is operating at its best with the CareTrack telematics system, providing powerful insight into machine conditions and performance. With ActiveCare Direct, Volvo will look after your machines, with our Uptime Center monitoring data and contacting you if action is required.



Match and attach

Get the most out of your wheeled excavator with our range of purpose-built attachments, designed to work in perfect harmony with your machine. Form one solid and reliable unit that delivers improved cycle times and increased fuel efficiency, by customizing your machine with quality Volvo attachments, which match your needs.



Here to support you

Maintain productivity and machine uptime with our range of widely available, tested and approved Genuine Volvo Parts – all backed by Volvo warranty. Here with the complete solution, we'll help you stay on track, offering flexible maintenance and repair options, as well as planned servicing, to extend the life of your excavator.





SIMPLE TO SERVICE

Keep your machine up and running with ease thanks to simple servicing. Grouped greasing points and filters are easily accessed behind wide-opening engine doors, providing ground-level access to daily service checkpoints. Furthermore, the pivoting AC condenser is fixed with a flexible latch, improving access to the radiators, for easy cleaning and increased component life.

Simply the best

Compact machine, big performance

- Shortest rear (1.55m / 5' 1") and front swing radius (1.81m / 5' 11")
- In-line outriggers for additional compactness (Option) **NEW**
- Best-in-class stability
- Fixed mounted boom with no pivot: superior digging & lifting performance
- 2-pieces boom: work closer to the machine

Enhanced versatility

- 4-wheel steering (Option) **NEW**
- Divided blades: level the machine in a wider variety of locations (Option) **NEW**
- Take on any angle with Steelwrist® tiltrotators
- Range of Volvo Attachments
- Trailer hitch
- Drawer type toolbox
- Easy to transport: optimized tie-down points & low machine height



Do more

- Travel up to 35km/h (22mph)
- Boom Suspension System reduces bouncing (Option)
- Get straight to work once you stop with the Automatic digging brake
- Steelwrist® Auto Connect Quick Coupler: attach hydraulic tools directly from the cab
- Dig Assist apps: more accurate, faster digging process (Option)

A clearer view

- Best-in-class visibility to the right
- Volvo Smart View: real-time, overhead view
- Welcome lights (Option)
- LED work light packages

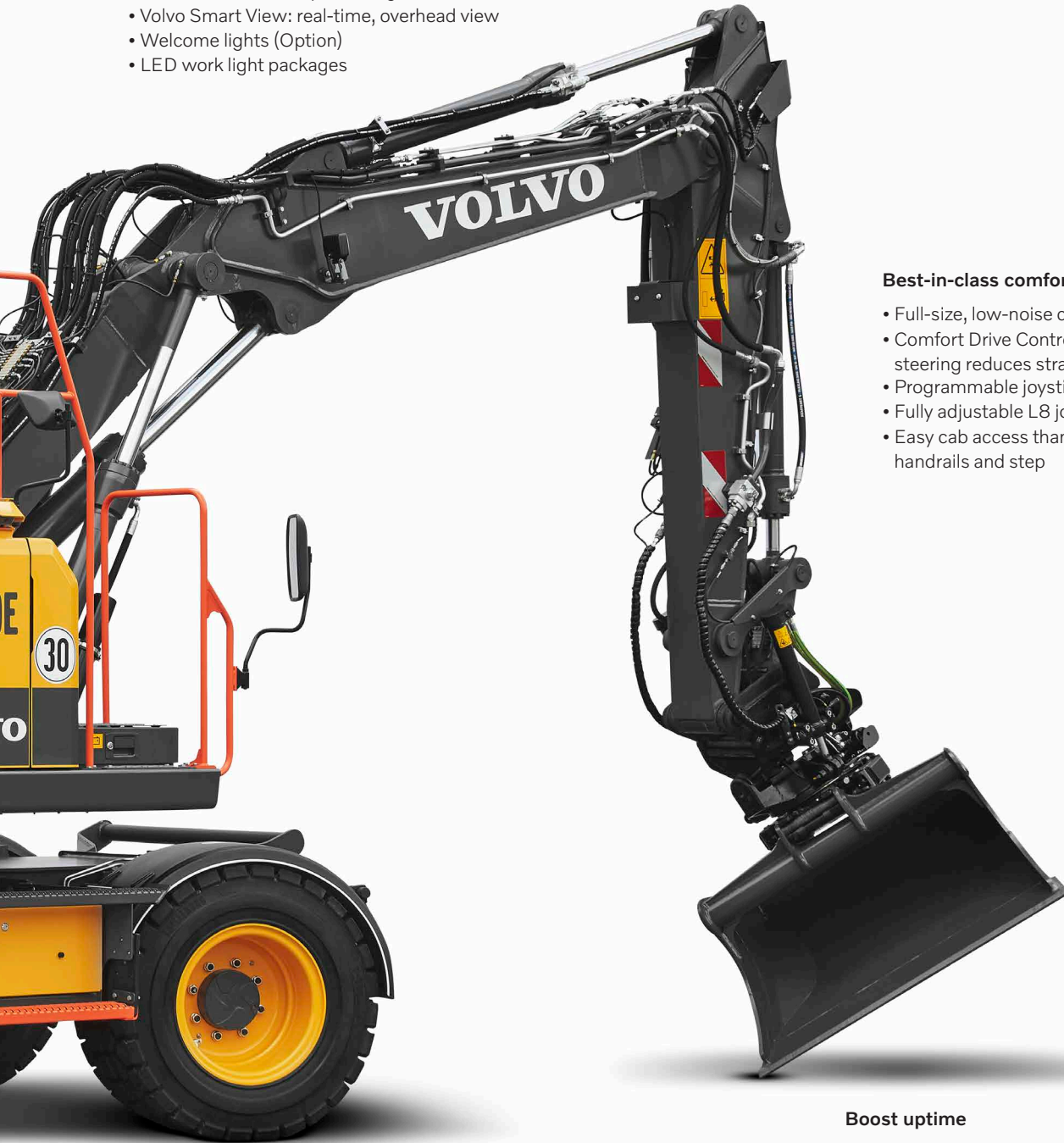

Best-in-class comfort

- Full-size, low-noise cab
- Comfort Drive Control: joystick steering reduces strain
- Programmable joystick buttons
- Fully adjustable L8 joystick (Option)
- Easy cab access thanks to bright handrails and step

Simple to service

- Grouped greasing points and filters
- Wide-opening engine doors
- Ground level access to daily service checkpoints
- Pivoting AC condenser, improving access to the radiators

Boost uptime

- Axle-mounted mudguards: cleaner machine
- Attachment Management System: pre-program up to 32 attachments without the need of a service technician
- ActiveCare Direct: 24/7 machine monitoring & weekly reports
- Genuine Volvo Parts
- Maintenance & Repair agreements

Volvo EWR130E in detail

Engine

Volvo Construction Equipment is ready to comply with the tough EPA Tier 4 Final legislation for off-road vehicles with the introduction of a cascade of innovations in its new generation engines with Volvo Advanced combustion technology (V-ACT).

Volvo machines are equipped with in-line turbo charged diesel engine with high pressure unit injector system. The engine features a externally cooled exhaust gas re-circulation (E-EGR), a Diesel Particulate Filter (DPF) and a Selective Catalytic Reduction (SCR) with AdBlue®.

Engine	Volvo	D4J
Max. power at	r/min (r/s)	2,000 (33.3)
Net (ISO9249/SAEJ1349)	kW (hp)	89 (119)
Gross (ISO 14396/SAE J1995)	kW (hp)	90 (121)
Max. torque	Nm (ft lbf)	566 (417)
at engine speed	r/min (r/s)	1,500 (25)
No. of cylinders		4
Displacement	l (in ³)	4.04 (247)
Bore	mm (in)	101 (3.98)
Stroke	mm (in)	126 (4.96)

Electrical system

High-capacity electrical system that is well protected. Waterproof double-lock harness plugs are used to secure corrosion-free connections. The main relays and solenoid valves are shielded to prevent damage. The master switch is standard.

Voltage	V	24
Batteries	V	2 x 12
Battery capacity	Ah	2 x 100
Alternator	V/Ah	24/120
Alternator rating	W	3 360

Undercarriage

Drive train: A variable axle piston motor in combination with a power shift gearbox supplies 3 speeds. The gearbox distributes the energy via propeller shafts to the axles.

Wheels: Alternative single and twin wheels available.

Front axle: Robust excavator axle with automatic or operator controlled front axle oscillation lock.

Oscillation	± °	7
with mudguards	± °	5
Twin wheels	type	9-20
Tractive force (net)	kN (lbf)	84 (18,884)
Travel speed, on road	km/h (mi/h)	20 / 30 / 35 (12.4 / 18.6 / 21.7)
Travel speed, off road	km/h (mi/h)	5.0 / 8.5 (3.1 / 5.3)
Travel speed, creep	km/h (mi/h)	3 (1.86)
Min. turning radius	m (ft)	7.0 with 2WS / 4.3 with 4WS (23 ft with 2WS / 14.1 ft with 4WS)

Travel speeds may depend on to local regulations

Cab

New design Volvo Care Cab with operator protective structure, large and roomy interior. One way travel pedal with rocker switch control (F-N-R) on the right joystick. One-touch release for digging brake pedal.

Audio system with remote control and Bluetooth system for hands free phoning. Independently adjustable joystick consoles.

Excellent all-round visibility provided by maximized cab class, transparent roof hatch, 2-piece sliding door window and long stroke, easy to adjust and new narrow steering column. The liftable front windshield can easily be stored in the inside roof space and clipped in position. The removable lower front glass can be stored in the side door pocket. Interior lighting consists of one reading light and one light with timer.

The pressurized and filtered cab air is supplied by a 14-vent climate-control providing fast defrosting and high cooling and heating performance. Viscous/spring mounted suspension cushions protect the operator from vibrations.

Deluxe air-suspension seat with adjustable seat suspension, height, tilt, recline and forward-backward settings.(option)

Adjustable, easy to read 8.3" LCD color monitor provides real time information of machine functions and important diagnostic information and is switchable to rear view camera monitor(standard) / side view camera (option). A new multi function button on left hand joystick with programmable function to improve the operator comfort. Refrigerant of the type R134a is used when this machine is equipped with air conditioning. Contains fluorinated greenhouse gas R134a, Global Warming Potential 1.430 t CO₂-eq.

Hydraulic System

Load sensing hydraulic system with pressure compensated valves. Load independence of movements. Flow sharing feature, combined with a high flow pump (power regulation). The system gives superior manoeuvrability and fast movements, for optimal working result and economy.

The following working modes are included in the system:

Parking mode (P): Parking position for optimal safety.

Travel mode (T): Engine speed is controlled by travel pedal stroke for low fuel consumption and noise.

Working mode (W): Full working flow with adjustable engine rpm for normal working and best speed utilisation.

Power Boost: All digging and lifting forces are increased.

Main pump (type low noise axial piston pump)

Max. flow	l/min (gal/min)	275 (72.6)
-----------	-----------------	------------

Brake + steering pump (type low noise gear pump)

Max. flow	l/min (gal/min)	48 (12.7)
-----------	-----------------	-----------

Attachment circuit

Max. flow	l/min (gal/min)	200 (52.8)
-----------	-----------------	------------

Relief valve setting pressure

Implement	MPa (psi)	32.5 / 36 (4,714 / 5,221)
Travel system	MPa (psi)	36 (5,221)
Slew system	MPa (psi)	25 (3,626)
Pilot system	MPa (psi)	3.5 (508)

Brake system

Service brakes: servo-hydraulically manoeuvred self-adjusting wet multidiscs with two separate brake circuits.

Parking brake: negative wet disc in gear housing, spring applied and pressure released.

Digging brake: service brake with mechanical lock system.

Security system: The 2-circuit travel brakes are supplied with two accumulators in the event of failure in the service brake system.

Swing system

The superstructure is slewed by the means of a radial piston motor without reduction gear.

Automatic slew holding brake and anti-rebound valve are standard.

Max. slew speed	r/min	8
Max. slew torque	kNm (ft lbf)	34 (25,077)

Service Refill

Fuel tank	l (gal)	150 (39.6)
DEF/AdBlue® tank	l (gal)	25 (6.6)
Hydraulic system, total	l (gal)	200 (52.8)
Hydraulic tank	l (gal)	104 (27.5)
Engine oil	l (gal)	16 (4.2)
Engine coolant	l (gal)	32 (8.5)
Transmission	l (gal)	2.5 (0.66)

Axle differential:

Front axle	l (gal)	7.3 (1.93)
Rear axle	l (gal)	8 (2.11)
Final drive	l (gal)	1.9 (steering hubs), 2.1 (rear rigid hubs) (0.5 (steering hubs), 0.55 (rear rigid hubs))

Total Machine Weights

Machine with divided blade twin mitas tires / 4.85 m (15.9 ft) boom / 2.1 m (6.9 ft) arm with S50 and 600 l (158 gal) / 370 kg (816 lb) bucket

With divided dozer blade front and outriggers rear	kg (lb)	14 200 (31,306)
--	---------	-----------------

With divided dozer blade rear only	kg (lb)	13 400 (29,542)
------------------------------------	---------	-----------------

With divided dozer blade front and std. blade rear	kg (lb)	14 400 (31,747)
--	---------	-----------------

With std. dozer blade front and outriggers rear	kg (lb)	14 100 (31,085)
---	---------	-----------------

Machine with single Camso tires b 2-piece boom 4.85 m (15.9 ft) boom / 2.1 m (6.9 ft) arm with S50 and 600 l (158 gal) / 370 kg (816 lb) bucket

With std. dozer blade rear only	kg (lb)	12 900 (28,440)
---------------------------------	---------	-----------------

Sound Level

Sound pressure level in cab according to ISO 6396

L _{pA}	dB	71
External sound level according to ISO 6395 and EU Noise Directive 2000/14/EC		
L _{WA} (standard)	dB	99
L _{WA} (tropical)	dB	100

Specifications

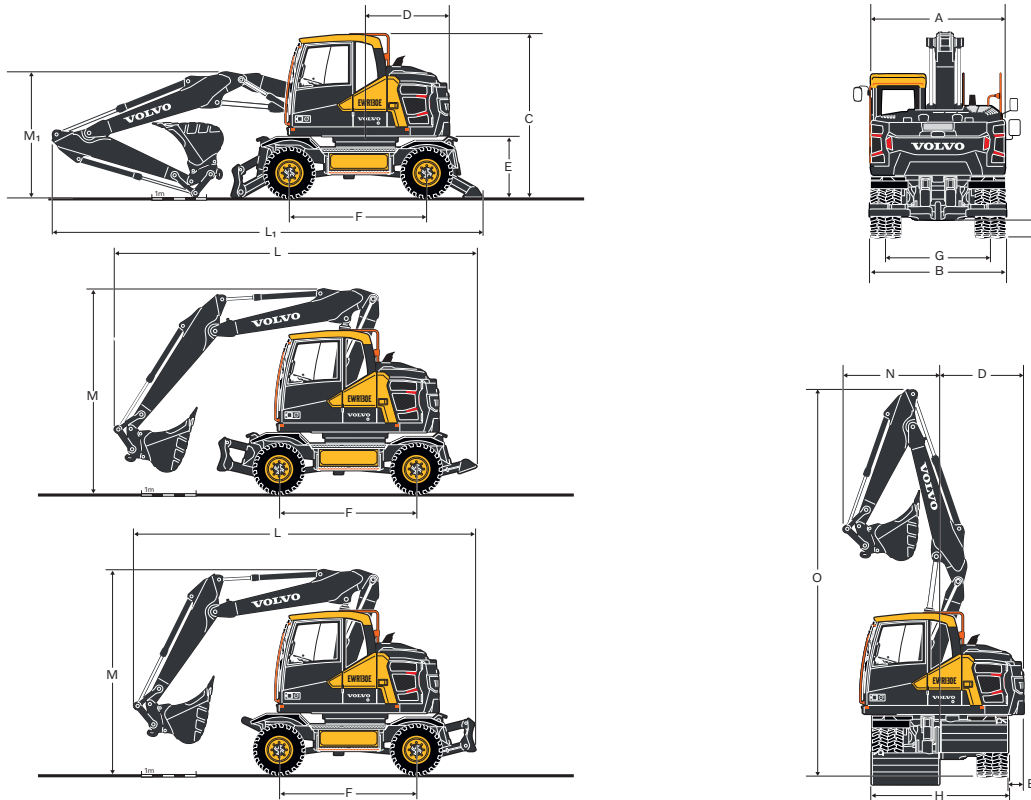

DIMENSIONS

Description	Unit	4.85 m (15'11") 2-piece boom			
A Overall width of superstructure	mm ft in	2,500		8'2"	
B Overall width	mm ft in	2,540		8'4"	
C Overall height of cab	mm ft in	3,050		10'0"	
D Tail slew radius	mm ft in	1,555		5'1"	
E Counterweight clearance	mm ft in	1,140		3'9"	
E ₁ Counterweight overhang	mm ft in	285		0'11"	
F Wheel base	mm ft in	2,550		8'4"	
G Tread	mm ft in	1,940		6'4"	
H Blade width	mm ft in	2,540		8'4"	
Outrigger width (front or rear)	mm ft in	2,540		8'4"	
I Min. ground clearance	mm ft in	315		1'0"	
		Arm			
		2.1 (6'11") m		2.4 m (7'10") arm	
L Overall length travel position	mm ft in	6,390	20'12"	6,740	22'1"
M Overall height of boom travel position	mm ft in	3,810	12'6"	3,810	12'6"
L ₁ Overall length transport position	mm ft in	8,010	26'3"	8,025	26'4"
M ₁ Overall height of boom transport position	mm ft in	2,340	7'8"	2,450	8'0"
N Front overhang	mm ft in	1,810	5'11"	1,950	6'5"
O height at min front overhang	mm ft in	7,190	23'7"	7,180	23'7"

UNDERCARRIAGE DIMENSIONS

Description	Unit	undercarriage with rear blade		undercarriage with front outrigger rear blade	
P	mm ft in	1,410	4'8"	1,410	4'8"
P ₁	mm ft in	1,140	3'9"	1,140	3'9"
Q	mm ft in	2,550	8'4"	2,550	8'4"
R	mm ft in	690	2'3"	1,170	3'10"
R ₁	mm ft in	1,100	3'7"	1,100	3'7"
T	mm ft in	4,340	14'3"	4,820	15'10"

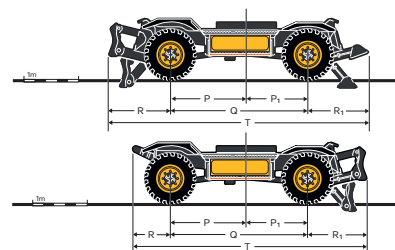

Specifications

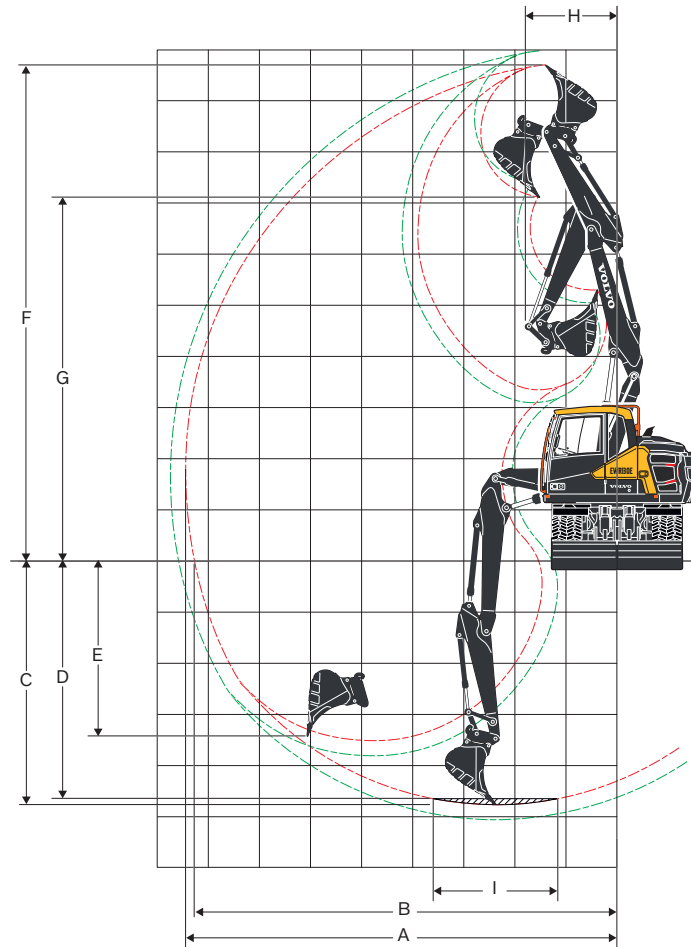

WORKING RANGES WITH DIRECT FIT BUCKET

		Unit		4.85 m (15'11") 2-piece boom EWR130E			
				Arm			
		m	ft in	2.1	6'11"	2.4	7'10"
A	Max. digging reach	mm	ft in	8,444	27'8"	8,733	28'8"
B	Max. digging reach on ground	mm	ft in	8,275	27'2"	8,570	28'1"
C	Max. digging depth	mm	ft in	4,768	15'8"	5,067	16'7"
D	Max. digging depth (l = 2.44 m, 8'0" level)	mm	ft in	4,650	15'3"	4,955	16'3"
E	Max. vertical wall digging depth	mm	ft in	3,429	11'3"	3,710	12'2"
F	Max. cutting height	mm	ft in	9,698	31'10"	9,971	32'9"
G	Max. dumping height	mm	ft in	7,117	23'4"	7,390	24'3"
H	Min. front slew radius	mm	ft in	1,806	5'11"	1,948	6'5"

DIGGING FORCES WITH DIRECT FIT BUCKET

	kN	lbf	2.1	6'11"	2.4	7'10"
Breakout force (bucket) (ISO)	82*	18,435*	82*	18,435*	82*	18,435*
Tearout force (ISO)	62*	13,940*	62*	13,940*	56*	12,590*

* with powerboost

Max. recommended sizes for quick fit buckets

	l	gal	2.1	6'11"	2.4	7'10"
S50 QF Bucket (1.8 t/m ³ 3,034 lb/yd ³)	600	158	600	158	600	158
S60 QF Bucket (1.8 t/m ³ 3,034 lb/yd ³)	700	185	660	174	660	174

Note: 1. Bucket size based on SAE-J296, heaped material with a 1:1 angle of repose. | 2. "Max permitted sizes" are for reference only and are not necessarily available from the factory. | 3. "Max permitted sizes" are for heavy counterweight. TR not recommended for S60 or SQ60 coupler

LIFTING CAPACITY EWR130E

At the arm end, without bucket and quick fit. For lifting capacity including bucket/quick fit, simply subtract actual weight of those parts from the following values. Unit: ● 1,000 kg / ■ 1,000 lb

Notes: 1. Working pressure with Power Boost = 5221 psi/36 mPa. 2. The above values are in compliance with ISO standard 10 567. They do not exceed 87 % of hydraulic lifting capacity or 75 % of tipping load, with the machine on firm, level ground. 3. Load capacities marked with an asterisk (*) are limited by machine's hydraulic lifting capacity rather than tipping load.

	Lifting point		Reach from machine centre (u = support up/d = support down)																		
			3.0 m, 10 ft				4.5 m, 15 ft				6.0 m, 20 ft				Max.						
			Across UC		Along UC		Across UC		Along UC		Across UC		Along UC		Across UC		Along UC		Max.		
			u	d	u	d	u	d	u	d	u	d	u	d	u	d					
Boom: 4.85 m (15'11") 2-piece Arm: 2.1 m (6'11") Blade front and Outrigger rear	7.5 m	●	5.1*	5.1*	5.1*	5.1*											3.8	3.9*	3.9*	3.9*	3.8 m
	25 ft	■	11.2*	11.2*	11.2*	11.2*											8.4	8.6*	8.6*	8.6*	12.5 ft
	6 m	●	4.2*	4.2*	4.2*	4.2*	3.0	4.0	4.3*	4.3*							2.1	2.8	3.1*	3.1*	5.6 m
	20 ft	■	9.3*	9.3*	9.3*	9.3*	6.6	8.8	9.5*	9.5*							4.6	6.2	6.8*	6.8*	18.4 ft
	4.5 m	●	4.8*	4.8*	4.8*	4.8*	2.9	3.9	4.4	4.6*	1.8	2.5	2.8	4.0*	1.6	2.1	2.4	2.8*	2.8*	6.5 m	
	15 ft	■	10.6*	10.6*	10.6*	10.6*	6.4	8.6	9.7	10.1*	4.0	5.5	6.2	8.8*	3.5	4.6	5.3	6.2*	6.2*	21.3 ft	
	3 m	●					2.7	3.7	4.2	5.3*	1.8	2.4	2.7	4.2*	1.4	1.9	2.1	2.8*	2.8*	7.0 m	
	10 ft	■					6.0	8.2	9.3	11.7*	4.0	5.3	6.0	9.3*	3.1	4.2	4.6	6.2*	6.2*	23.0 ft	
	1.5 m	●					2.5	3.5	4.0	6.0*	1.7	2.3	2.6	4.4*	1.3	1.8	2.0	2.9*	2.9*	7.1 m	
	5 ft	■					5.5	7.7	8.8	13.2*	3.7	5.1	5.7	9.7*	2.9	4.0	4.4	6.4*	6.4*	23.3 ft	
	0 m	●					2.4	3.4	3.8	6.0*	1.6	2.2	2.5	4.4*	1.3	1.8	2.1	3.2*	3.2*	7.0 m	
	0 ft	■					5.3	7.5	8.4	13.2*	3.5	4.9	5.5	9.7*	2.9	4.0	4.6	7.1*	7.1*	23.0 ft	
	-1.5 m	●					2.4	3.3	3.8	5.4*	1.6	2.2	2.5	3.8*	1.5	2.1	2.3	3.3*	3.3*	6.4 m	
	5 ft	■					5.3	7.3	8.4	11.9*	3.5	4.9	5.5	8.4*	3.3	4.6	5.1	7.3*	7.3*	21.0 ft	
Boom: 4.85 m (15'11") 2-piece Arm: 2.4 m (7'10") Blade front and Outrigger rear	7.5 m	●	4.4*	4.4*	4.4*	4.4*											3.1	3.2*	3.2*	3.2*	4.3 m
	25 ft	■	9.7*	9.7*	9.7*	9.7*											6.8	7.1*	7.1*	7.1*	14.1 ft
	6 m	●	3.5*	3.5*	3.5*	3.5*	3.0	3.9*	3.9*	3.9*							1.9	2.5	2.6*	2.6*	5.9 m
	20 ft	■	7.7*	7.7*	7.7*	7.7*	6.6	8.6*	8.6*	8.6*							4.2	5.5	5.7*	5.7*	19.4 ft
	4.5 m	●	3.7*	3.7*	3.7*	3.7*	2.9	3.9	4.3*	4.3*	1.8	2.5	2.8	3.8*	1.5	2.0	2.2	2.4*	2.4*	6.8 m	
	15 ft	■	8.2*	8.2*	8.2*	8.2*	6.4	8.6	9.5*	9.5*	4.0	5.5	6.2	8.4*	3.3	4.4	4.9	5.3*	5.3*	22.3 ft	
	3 m	●					2.7	3.7	4.2	5.1*	1.8	2.4	2.7	4.1*	1.3	1.8	2.0	2.4*	2.4*	7.3 m	
	10 ft	■					6.0	8.2	9.3	11.2*	4.0	5.3	6.0	9.0*	2.9	4.0	4.4	5.3*	5.3*	24.0 ft	
	1.5 m	●					2.5	3.5	4.0	5.9*	1.7	2.3	2.6	4.3*	1.2	1.7	1.9	2.5*	2.5*	7.4 m	
	5 ft	■					5.5	7.7	8.8	13.0*	3.7	5.1	5.7	9.5*	2.6	3.7	4.2	5.5*	5.5*	24.3 ft	
	0 m	●	3.3*	3.3*	3.3*	3.3*	2.4	3.4	3.8	6.0*	1.6	2.2	2.5	4.4*	1.2	1.7	1.9	2.7*	2.7*	7.3 m	
	0 ft	■	7.3*	7.3*	7.3*	7.3*	5.3	7.5	8.4	13.2*	3.5	4.9	5.5	9.7*	2.6	3.7	4.2	6.0*	6.0*	24.0 ft	
	-1.5 m	●	4.2	6.3	7.0*	7.0*	2.3	3.3	3.8	5.3*	1.6	2.2	2.5	4.0*	1.4	1.9	2.2	3.2*	3.2*	6.7 m	
	5 ft	■	9.3	13.9	15.4*	15.4*	5.1	7.3	8.4	12.1*	3.5	4.9	5.5	8.8*	3.1	4.2	4.9	7.1*	7.1*	22.0 ft	
Boom: 4.85 m (15'11") 2-piece Arm: 2.1 m (6'11") Outrigger front and Blade rear	7.5 m	●	5.1*	5.1*	5.1*	5.1*											3.8	3.9*	3.9*	3.9*	3.8 m
	25 ft	■	11.2*	11.2*	11.2*	11.2*											8.4	8.6*	8.6*	8.6*	12.5 ft
	6 m	●	4.2*	4.2*	4.2*	4.2*	3.0	4.0	4.3*	4.3*							2.1	2.8	3.1*	3.1*	5.6 m
	20 ft	■	9.3*	9.3*	9.3*	9.3*	6.6	8.8	9.5*	9.5*							4.6	6.2	6.8*	6.8*	18.4 ft
	4.5 m	●	4.8*	4.8*	4.8*	4.8*	2.9	3.9	4.6*	4.6*	1.8	2.5	2.9	4.0*	1.6	2.2	2.5	2.8*	2.8*	6.5 m	
	15 ft	■	10.6*	10.6*	10.6*	10.6*	6.4	8.6	10.1*	10.1*	4.0	5.5	6.4	8.8*	3.5	4.9	5.5	6.2*	6.2*	21.3 ft	
	3 m	●					2.7	3.7	4.4	5.3*	1.8	2.4	2.8	4.2*	1.4	1.9	2.2	2.8*	2.8*	7.0 m	
	10 ft	■					6.0	8.2	9.7	11.7*	4.0	5.3	6.2	9.3*	3.1	4.2	4.9	6.2*	6.2*	23.0 ft	
	1.5 m	●					2.5	3.5	4.1	6.0*	1.7	2.3	2.7	4.4*	1.3	1.8	2.1	2.9*	2.9*	7.1 m	
	5 ft	■					5.5	7.7	9.0	13.2*	3.7	5.1	6.0	9.7*	2.9	4.0	4.6	6.4*	6.4*	23.3 ft	
	0 m	●					2.4	3.4	4.0	6.0*	1.6	2.3	2.6	4.4*	1.3	1.8	2.2	3.2*	3.2*	7.0 m	
	0 ft	■					5.3	7.5	8.8	13.2*	3.5	5.1	5.7	9.7*	2.9	4.0	4.9	7.1*	7.1*	23.0 ft	
	-1.5 m	●					2.4	3.4	4.0	5.4*	1.6	2.2	2.6	3.8*	1.5	2.1	2.4	3.3*	3.3*	6.4 m	
	5 ft	■					5.3	7.5	8.8	11.9*	3.5	4.9	5.7	8.4*	3.3	4.6	5.3	7.3*	7.3*	21.0 ft	
Boom: 4.85 m (15'11") 2-piece Arm: 2.4 m (7'10") Outrigger front and Blade rear	7.5 m	●	4.4*	4.4*	4.4*	4.4*											3.1	3.2*	3.2*	3.2*	4.3 m
	25 ft	■	9.7*	9.7*	9.7*	9.7*											6.8	7.1*	7.1*	7.1*	14.1 ft
	6 m	●	3.5*	3.5*	3.5*	3.5*	3.0	3.9*	3.9*	3.9*							1.9	2.5	2.6*	2.6*	5.9 m
	20 ft	■	7.7*	7.7*	7.7*	7.7*	6.6	8.6*	8.6*	8.6*							4.2	5.5	5.7*	5.7*	19.4 ft
	4.5 m	●	3.7*	3.7*	3.7*	3.7*	2.9	4.0	4.3*	4.3*	1.8	2.5	2.9	3.8*	1.5	2.0	2.3	2.4*	2.4*	6.8 m	
	15 ft	■	8.2*	8.2*	8.2*	8.2*	6.4	8.8	9.5*	9.5*	4.0	5.5	6.4	8.4*	3.3	4.4	5.1	5.3*	5.3*	22.3 ft	
	3 m	●					2.7	3.7	4.4	5.1*	1.8	2.4	2.8	4.1*	1.3	1.8	2.1	2.4*	2.4*	7.3 m	
	10 ft	■					6.0	8.2	9.7	11.2*	4.0	5.3	6.2	9.0*	2.9	4.0	4.6	5.3*	5.3*	24.0 ft	
	1.5 m	●					2.5	3.5	4.2	5.9*	1.7	2.3	2.7	4.3*	1.2	1.7	2.0	2.5*	2.5*	7.4 m	
	5 ft	■					5.5	7.7	9.3	13.0*	3.7	5.1	6.0	9.5*	2.6	3.7	4.4	5.5*	5.5*	24.3 ft	
	0 m	●	3.3*	3.3*	3.3*	3.3*	2.4	3.4	4.0	6.0*	1.6	2.2	2.6	4.4*	1.2	1.7	2.0	2.7*	2.7*	7.3 m	
	0 ft	■	7.3*	7.3*	7.3*	7.3*	5.3	7.5	8.8	13.2*	3.5	4.9	5.7	9.7*	2.6	3.7	4.4	6.0*	6.0*	24.0 ft	
	-1.5 m	●	4.2	6.4	7.0*	7.0*	2.3	3.3	4.0	5.5*	1.6	2.2	2.6	4.0*	1.4	1.9	2.3	3.2*	3.2*	6.7 m	
	5 ft	■	9.3	14.1	15.4*	15.4*	5.1	7.3	8.8	12.1*	3.5	4.9	5.7	8.8*	3.1	4.2	5.1	7.1*	7.1*	22.0 ft	

Specifications

LIFTING CAPACITY EWR130E

At the arm end, without bucket and quick fit. For lifting capacity including bucket/quick fit, simply subtract actual weight of those parts from the following values. Unit: ● 1,000 kg / ■ 1,000 lb

Notes: 1. Working pressure with Power Boost = 5221 psi/36 mPa. 2. The above values are in compliance with ISO standard 10 567. They do not exceed 87 % of hydraulic lifting capacity or 75 % of tipping load, with the machine on firm, level ground. 3. Load capacities marked with an asterisk (*) are limited by machine's hydraulic lifting capacity rather than tipping load.

	Lifting point		Reach from machine centre (u = support up/d = support down)																			
			3.0 m, 10 ft				4.5 m, 15 ft				6.0 m, 20 ft				Max.							
			Across UC		Along UC		Across UC		Along UC		Across UC		Along UC		Across UC		Along UC		Max.			
			u	d	u	d	u	d	u	d	u	d	u	d	u	d						
Boom: 4.85 m (15'11") 2-piece Arm: 2.1 m (6'11") 4 Outrigger (front and rear)	7.5 m	●	5.1*	5.1*	5.1*	5.1*											3.8	3.9*	3.9*	3.9*	3.8 m	
	25 ft	■	11.2*	11.2*	11.2*	11.2*												8.4	8.6*	8.6*	8.6*	12.5 ft
	6 m	●	4.2*	4.2*	4.2*	4.2*	2.9	3.8	4.3*	4.3*								2.0	2.7	3.1*	3.1*	5.6 m
	20 ft	■	9.3*	9.3*	9.3*	9.3*	6.4	8.4	9.5*	9.5*								4.4	6.0	6.8*	6.8*	18.4 ft
	4.5 m	●	4.8*	4.8*	4.8*	4.8*	2.8	3.7	4.5	4.6*	1.8	2.4	2.8	4.0*	1.6	2.1	2.4	2.8	2.4	2.8*	2.8*	6.5 m
	15 ft	■	10.6*	10.6*	10.6*	10.6*	6.2	8.2	9.9	10.1*	4.0	5.3	6.2	8.8*	3.5	4.6	5.3	6.2*	6.2*	6.2*	6.2*	21.3 ft
	3 m	●					2.6	3.5	4.2	5.3*	1.7	2.3	2.7	4.2*	1.3	1.8	2.1	2.8*	2.8*	2.8*	2.8*	7.0 m
	10 ft	■					5.7	7.7	9.3	11.7*	3.7	5.1	6.0	9.3*	2.9	4.0	4.6	6.2*	6.2*	6.2*	6.2*	23.0 ft
	1.5 m	●					2.4	3.3	4.0	6.0*	1.6	2.2	2.6	4.4*	1.3	1.7	2.0	2.9*	2.9*	2.9*	2.9*	7.1 m
	5 ft	■					5.3	7.3	8.8	13.2*	3.5	4.9	5.7	9.7*	2.9	3.7	4.4	6.4*	6.4*	6.4*	6.4*	23.3 ft
	0 m	●					2.3	3.2	3.9	6.0*	1.6	2.1	2.6	4.4*	1.3	1.8	2.1	3.2*	3.2*	3.2*	3.2*	7.0 m
	0 ft	■					5.1	7.1	8.6	13.2*	3.5	4.6	5.7	9.7*	2.9	4.0	4.6	7.1*	7.1*	7.1*	7.1*	23.0 ft
	-1.5 m	●					2.3	3.2	3.9	5.4*	1.6	2.1	2.6	3.8*	1.5	2.0	2.3	3.3*	3.3*	3.3*	3.3*	6.4 m
	5 ft	■					5.1	7.1	8.6	11.9*	3.5	4.6	5.7	8.4*	3.3	4.4	5.1	7.3*	7.3*	7.3*	7.3*	21.0 ft
Boom: 4.85 m (15'11") 2-piece Arm: 2.4 m (7'10") 4 Outrigger (front and rear)	7.5 m	●	4.4*	4.4*	4.4*	4.4*											3.1	3.2*	3.2*	3.2*	4.3 m	
	25 ft	■	9.7*	9.7*	9.7*	9.7*												6.8	7.1*	7.1*	7.1*	14.1 ft
	6 m	●	3.5*	3.5*	3.5*	3.5*	3.0	3.9	3.9*	3.9*								1.9	2.4	2.6*	2.6*	5.9 m
	20 ft	■	7.7*	7.7*	7.7*	7.7*	6.6	8.6	8.6*	8.6*								4.2	5.3	5.7*	5.7*	19.4 ft
	4.5 m	●	3.7*	3.7*	3.7*	3.7*	2.9	3.8	4.3*	4.3*	1.8	2.4	2.8	3.8*	1.4	1.9	2.3	2.4*	2.4*	2.4*	2.4*	6.8 m
	15 ft	■	8.2*	8.2*	8.2*	8.2*	6.4	8.4	9.5*	9.5*	4.0	5.3	6.2	8.4*	3.1	4.2	5.1	5.3*	5.3*	5.3*	5.3*	22.3 ft
	3 m	●					2.7	3.6	4.3	5.1*	1.7	2.3	2.7	4.1*	1.3	1.7	2.0	2.4*	2.4*	2.4*	2.4*	7.3 m
	10 ft	■					6.0	7.9	9.5	11.2*	3.7	5.1	6.0	9.0*	2.9	3.7	4.4	5.3*	5.3*	5.3*	5.3*	24.0 ft
	1.5 m	●					2.5	3.3	4.0	5.9*	1.7	2.2	2.6	4.3*	1.2	1.6	1.9	2.5*	2.5*	2.5*	2.5*	7.4 m
	5 ft	■					5.5	7.3	8.8	13.0*	3.7	4.9	5.7	9.5*	2.6	3.5	4.2	5.5*	5.5*	5.5*	5.5*	24.3 ft
	0 m	●	3.3*	3.3*	3.3*	3.3*	2.3	3.2	3.9	6.0*	1.6	2.1	2.6	4.4*	1.2	1.6	2.0	2.7*	2.7*	2.7*	2.7*	7.3 m
	0 ft	■	7.3*	7.3*	7.3*	7.3*	5.1	7.1	8.6	13.2*	3.5	4.6	5.7	9.7*	2.6	3.5	4.4	6.0*	6.0*	6.0*	6.0*	24.0 ft
	-1.5 m	●	4.2	6.0	7.0*	7.0*	2.3	3.2	3.9	5.3*	1.6	2.1	2.5	4.0*	1.4	1.8	2.2	3.2*	3.2*	3.2*	3.2*	6.7 m
	5 ft	■	9.3	13.2	15.4*	15.4*	5.1	7.1	8.6	12.1*	3.5	4.6	5.5	8.8*	3.1	4.0	4.9	7.1*	7.1*	7.1*	7.1*	22.0 ft
Boom: 4.85 m (15'11") 2-piece Arm: 2.1 m (6'11") Blade rear only	7.5 m	●	5.1*	5.1*	5.1*	5.1*											3.6	3.9*	3.9*	3.9*	3.8 m	
	25 ft	■	11.2*	11.2*	11.2*	11.2*												7.9	8.6*	8.6*	8.6*	12.5 ft
	6 m	●	4.2*	4.2*	4.2*	4.2*	2.8	3.2	4.3*	4.3*								1.9	2.2	3.1*	3.1*	5.6 m
	20 ft	■	9.3*	9.3*	9.3*	9.3*	6.2	7.1	9.5*	9.5*								4.2	4.9	6.8*	6.8*	18.4 ft
	4.5 m	●	4.8*	4.8*	4.8*	4.8*	2.7	3.1	4.6*	4.6*	1.7	2.0	2.9	4.0*	1.5	1.7	2.6	2.8*	2.8*	2.8*	2.8*	6.5 m
	15 ft	■	10.6*	10.6*	10.6*	10.6*	6.0	6.8	10.1*	10.1*	3.7	4.4	6.4	8.8*	3.3	3.7	5.7	6.2*	6.2*	6.2*	6.2*	21.3 ft
	3 m	●					2.5	2.9	4.5	5.3*	1.6	1.9	2.9	4.2*	1.3	1.5	2.3	2.8*	2.8*	2.8*	2.8*	7.0 m
	10 ft	■					5.5	6.4	9.9	11.7*	3.5	4.2	6.4	9.3*	2.9	3.3	5.1	6.2*	6.2*	6.2*	6.2*	23.0 ft
	1.5 m	●					2.3	2.7	4.2	6.0*	1.5	1.8	2.8	4.3	1.2	1.4	2.2	2.9*	2.9*	2.9*	2.9*	7.1 m
	5 ft	■					5.1	6.0	9.3	13.2*	3.3	4.0	6.2	9.5	2.6	3.1	4.9	6.4*	6.4*	6.4*	6.4*	23.3 ft
	0 m	●					2.2	2.6	4.1	6.0*	1.5	1.8	2.7	4.3	1.2	1.4	2.2	3.2*	3.2*	3.2*	3.2*	7.0 m
	0 ft	■					4.9	5.7	9.0	13.2*	3.3	4.0	6.0	9.5	2.6	3.1	4.9	7.1*	7.1*	7.1*	7.1*	23.0 ft
	-1.5 m	●					2.2	2.6	4.1	5.4*	1.5	1.7	2.7	3.8*	1.4	1.6	2.5	3.3*	3.3*	3.3*	3.3*	6.4 m
	5 ft	■					4.9	5.7	9.0	11.9*	3.3	3.7	6.0	8.4*	3.1	3.5	5.5	7.3*	7.3*	7.3*	7.3*	21.0 ft
Boom: 4.85 m (15'11") 2-piece Arm: 2.4 m (7'10") Blade rear only	7.5 m	●	4.4*	4.4*	4.4*	4.4*											2.9	3.2*	3.2*	3.2*	4.3 m	
	25 ft	■	9.7*	9.7*	9.7*	9.7*												6.4	7.1*	7.1*	7.1*	14.1 ft
	6 m	●	3.5*	3.5*	3.5*	3.5*	2.8	3.3	3.9*	3.9*								1.7	2.0	2.6*	2.6*	5.9 m
	20 ft	■	7.7*	7.7*	7.7*	7.7*	6.2	7.3	8.6*	8.6*								3.7	4.4	5.7*	5.7*	19.4 ft
	4.5 m	●	3.7*	3.7*	3.7*	3.7*	2.7	3.2	4.3*	4.3*	1.7	2.0	3.0	3.8*	1.4	1.6	2.4	2.4*	2.4*	2.4*	2.4*	6.8 m
	15 ft	■	8.2*	8.2*	8.2*	8.2*	6.0	7.1	9.5*	9.5*	3.7	4.4	6.6	8.4*	3.1	3.5	5.3	5.3*	5.3*	5.3*	5.3*	22.3 ft
	3 m	●					2.5	3.0	4.5	5.1*	1.6	1.9	2.9	4.1*	1.2	1.4	2.1	2.4*	2.4*	2.4*	2.4*	7.3 m
	10 ft	■					5.5	6.6	9.9	11.2*	3.5	4.2	6.4	9.0*	2.6	3.1	4.6	5.3*	5.3*	5.3*	5.3*	24.0 ft
	1.5 m	●					2.3	2.7	4.3	5.9*	1.5	1.8	2.8	4.3*	1.1	1.3	2.0	2.5*	2.5*	2.5*	2.5*	7.4 m
	5 ft	■					5.1	6.0	9.5	13.0*	3.3	4.0	6.2	9.5*	2.4	2.9	4.4	5.5*	5.5*	5.5*	5.5*	24.3 ft
	0 m	●	3.3*	3.3*	3.3*	3.3*	2.2	2.6	4.1	6.0*	1.5	1.7	2.7	4.3	1.1	1.3	2.1	2.7*	2.7*	2.7*	2.7*	7.3 m
	0 ft	■	7.3*	7.3*	7.3*	7.3*	4.9	5.7	9.0	13.2*	3.3	3.7	6.0	9.5	2.4	2.9	4.6	6.0*	6.0*	6.0*	6.0*	24.0 ft
	-1.5 m	●	3.9	4.8	7.0*	7.0*	2.2	2.6	4.1	5.5*	1.5	1.7	2.7	4.0*	1.3	1.5	2.3	3.2*	3.2*	3.2*	3.2*	6.7 m
	5 ft	■	8.6	10.6	15.4*	15.4*	4.9	5.7	9.0	12.1*	3.3	3.7	6.0	8.8*	2.9	3.3	5.1	7.1*	7.1*	7.1*	7.1*	22.0 ft

LIFTING CAPACITY EWR130E

At the arm end, without bucket and quick fit. For lifting capacity including bucket/quick fit, simply subtract actual weight of those parts from the following values. Unit: ● 1,000 kg / ■ 1,000 lb

Notes: 1. Working pressure with Power Boost = 5221 psi/36 mPa. 2. The above values are in compliance with ISO standard 10 567. They do not exceed 87 % of hydraulic lifting capacity or 75 % of tipping load, with the machine on firm, level ground. 3. Load capacities marked with an asterisk (*) are limited by machine's hydraulic lifting capacity rather than tipping load.

	Lifting point		Reach from machine centre (u = support up/d = support down)																		
			3.0 m, 10 ft				4.5 m, 15 ft				6.0 m, 20 ft				Max.						
			Across UC		Along UC		Across UC		Along UC		Across UC		Along UC		Across UC		Along UC		Max.		
			u	d	u	d	u	d	u	d	u	d	u	d	u	d					
Boom: 4.85 m (15'11") 2-piece Arm: 2.1 m (6'11") Twin blade	7.5 m	●	5.1*	5.1*	5.1*	5.1*											3.8	3.9*	3.9*	3.9*	3.8 m
	25 ft	■	11.2*	11.2*	11.2*	11.2*											8.4	8.6*	8.6*	8.6*	12.5 ft
	6 m	●	4.2*	4.2*	4.2*	4.2*	3.0	4.2	4.3*	4.3*							2.1	2.9	3.1*	3.1*	5.6 m
	20 ft	■	9.3*	9.3*	9.3*	9.3*	6.6	9.3	9.5*	9.5*							4.6	6.4	6.8*	6.8*	18.4 ft
	4.5 m	●	4.8*	4.8*	4.8*	4.8*	2.9	4.1	4.6	4.6*	1.8	2.6	2.8	4.0*	1.6	2.2	2.5	2.8*	2.8*	6.5 m	
	15 ft	■	10.6*	10.6*	10.6*	10.6*	6.4	9.0	10.1	10.1*	4.0	5.7	6.2	8.8*	3.5	4.9	5.5	6.2*	6.2*	21.3 ft	
	3 m	●					2.7	3.9	4.3	5.3*	1.8	2.5	2.8	4.2*	1.4	2.0	2.2	2.8*	2.8*	7.0 m	
	10 ft	■					6.0	8.6	9.5	11.7*	4.0	5.5	6.2	9.3*	3.1	4.4	4.9	6.2*	6.2*	23.0 ft	
	1.5 m	●					2.5	3.7	4.1	6.0*	1.7	2.4	2.7	4.4*	1.3	1.9	2.1	2.9*	2.9*	7.1 m	
	5 ft	■					5.5	8.2	9.0	13.2*	3.7	5.3	6.0	9.7*	2.9	4.2	4.6	6.4*	6.4*	23.3 ft	
	0 m	●					2.4	3.5	4.0	6.0*	1.6	2.4	2.6	4.4*	1.3	1.9	2.1	3.2*	3.2*	7.0 m	
	0 ft	■					5.3	7.7	8.8	13.2*	3.5	5.3	5.7	9.7*	2.9	4.2	4.6	7.1*	7.1*	23.0 ft	
	-1.5 m	●					2.4	3.5	4.0	5.4*	1.6	2.4	2.6	3.8*	1.5	2.2	2.4	3.3*	3.3*	6.4 m	
	5 ft	■					5.3	7.7	8.8	11.9*	3.5	5.3	5.7	8.4*	3.3	4.9	5.3	7.3*	7.3*	21.0 ft	
Boom: 4.85 m (15'11") 2-piece Arm: 2.4 m (7'10") Twin blade	7.5 m	●	4.4*	4.4*	4.4*	4.4*											3.1	3.2*	3.2*	3.2*	4.3 m
	25 ft	■	9.7*	9.7*	9.7*	9.7*											6.8	7.1*	7.1*	7.1*	14.1 ft
	6 m	●	3.5*	3.5*	3.5*	3.5*	3.0	3.9*	3.9*	3.9*							1.9	2.6*	2.6*	2.6*	5.9 m
	20 ft	■	7.7*	7.7*	7.7*	7.7*	6.6	8.6*	8.6*	8.6*							4.2	5.7*	5.7*	5.7*	19.4 ft
	4.5 m	●	3.7*	3.7*	3.7*	3.7*	2.9	4.1	4.3*	4.3*	1.9	2.6	2.9	3.8*	1.5	2.1	2.3	2.4*	2.4*	6.8 m	
	15 ft	■	8.2*	8.2*	8.2*	8.2*	6.4	9.0	9.5*	9.5*	4.2	5.7	6.4	8.4*	3.3	4.6	5.1	5.3*	5.3*	22.3 ft	
	3 m	●					2.7	3.9	4.4	5.1*	1.8	2.5	2.8	4.1*	1.3	1.9	2.0	2.4*	2.4*	7.3 m	
	10 ft	■					6.0	8.6	9.7	11.2*	4.0	5.5	6.2	9.0*	2.9	4.2	4.4	5.3*	5.3*	24.0 ft	
	1.5 m	●					2.5	3.7	4.1	5.9*	1.7	2.4	2.7	4.3*	1.2	1.8	2.0	2.5*	2.5*	7.4 m	
	5 ft	■					5.5	8.2	9.0	13.0*	3.7	5.3	6.0	9.5*	2.6	4.0	4.4	5.5*	5.5*	24.3 ft	
	0 m	●	3.3*	3.3*	3.3*	3.3*	2.4	3.5	4.0	6.0*	1.6	2.4	2.6	4.4*	1.3	1.8	2.0	2.7*	2.7*	7.3 m	
	0 ft	■	7.3*	7.3*	7.3*	7.3*	5.3	7.7	8.8	13.2*	3.5	5.3	5.7	9.7*	2.9	4.0	4.4	6.0*	6.0*	24.0 ft	
	-1.5 m	●	4.3	6.7	7.0*	7.0*	2.4	3.5	3.9	5.3*	1.6	2.3	2.6	4.0*	1.4	2.0	2.2	3.2*	3.2*	6.7 m	
	5 ft	■	9.5	14.8	15.4*	15.4*	5.3	7.7	8.6	12.1*	3.5	5.1	5.7	8.8*	3.1	4.4	4.9	7.1*	7.1*	22.0 ft	
Boom: 4.85 m (15'11") 2-piece Arm: 2.1 m (6'11") Rear outrigger only	7.5 m	●	5.1*	5.1*	5.1*	5.1*											3.5	3.9*	3.9*	3.9*	3.8 m
	25 ft	■	11.2*	11.2*	11.2*	11.2*											7.7	8.6*	8.6*	8.6*	12.5 ft
	6 m	●	4.2*	4.2*	4.2*	4.2*	2.7	3.1	4.3*	4.3*							1.9	2.1	3.1*	3.1*	5.6 m
	20 ft	■	9.3*	9.3*	9.3*	9.3*	6.0	6.8	9.5*	9.5*							4.2	4.6	6.8*	6.8*	18.4 ft
	4.5 m	●	4.8*	4.8*	4.8*	4.8*	2.6	3.0	4.6	4.6*	1.6	1.9	2.9	3.9	1.4	1.6	2.5	2.8*	2.8*	6.5 m	
	15 ft	■	10.6*	10.6*	10.6*	10.6*	5.7	6.6	10.1	10.1*	3.5	4.2	6.4	8.6	3.1	3.5	5.5	6.2*	6.2*	21.3 ft	
	3 m	●					2.4	2.8	4.3	5.3*	1.6	1.8	2.8	3.8	1.2	1.4	2.2	2.8*	2.8*	7.0 m	
	10 ft	■					5.3	6.2	9.5	11.7*	3.5	4.0	6.2	8.4	2.6	3.1	4.9	6.2*	6.2*	23.0 ft	
	1.5 m	●					2.2	2.6	4.1	6.0*	1.5	1.7	2.7	3.7	1.1	1.3	2.1	2.8	2.8	7.1 m	
	5 ft	■					4.9	5.7	9.0	13.2*	3.3	3.7	6.0	8.2	2.4	2.9	4.6	6.2	6.2	23.3 ft	
	0 m	●					2.1	2.5	4.0	5.8	1.4	1.7	2.6	3.7	1.2	1.4	2.1	2.9	2.9	7.0 m	
	0 ft	■					4.6	5.5	8.8	12.8	3.1	3.7	5.7	8.2	2.6	3.1	4.6	6.4	6.4	23.0 ft	
	-1.5 m	●					2.1	2.4	4.0	5.4*	1.4	1.7	2.6	3.7	1.3	1.5	2.4	3.3*	3.3*	6.4 m	
	5 ft	■					4.6	5.3	8.8	11.9*	3.1	3.7	5.7	8.2	2.9	3.3	5.3	7.3*	7.3*	21.0 ft	
Boom: 4.85 m (15'11") 2-piece Arm: 2.4 m (7'10") Rear outrigger only	7.5 m	●	4.4*	4.4*	4.4*	4.4*											2.9	3.2	3.2*	3.2*	4.3 m
	25 ft	■	9.7*	9.7*	9.7*	9.7*											6.4	7.1	7.1*	7.1*	14.1 ft
	6 m	●	3.5*	3.5*	3.5*	3.5*	2.8	3.1	3.9*	3.9*							1.7	1.9	2.6*	2.6*	5.9 m
	20 ft	■	7.7*	7.7*	7.7*	7.7*	6.2	6.8	8.6*	8.6*							3.7	4.2	5.7*	5.7*	19.4 ft
	4.5 m	●	3.7*	3.7*	3.7*	3.7*	2.7	3.0	4.3*	4.3*	1.7	1.9	2.9	3.8*	1.3	1.5	2.3	2.4*	2.4*	6.8 m	
	15 ft	■	8.2*	8.2*	8.2*	8.2*	6.0	6.6	9.5*	9.5*	3.7	4.2	6.4	8.4*	2.9	3.3	5.1	5.3*	5.3*	22.3 ft	
	3 m	●					2.5	2.8	4.4	5.1*	1.6	1.8	2.8	3.8	1.2	1.3	2.0	2.4*	2.4*	7.3 m	
	10 ft	■					5.5	6.2	9.7	11.2*	3.5	4.0	6.2	8.4	2.6	2.9	4.4	5.3*	5.3*	24.0 ft	
	1.5 m	●					2.3	2.6	4.1	5.9*	1.5	1.7	2.7	3.7	1.1	1.2	2.0	2.5*	2.5*	7.4 m	
	5 ft	■					5.1	5.7	9.0	13.0*	3.3	3.7	6.0	8.2	2.4	2.6	4.4	5.5*	5.5*	24.3 ft	
	0 m	●	3.3*	3.3*	3.3*	3.3*	2.1	2.5	4.0	5.9	1.4	1.7	2.6	3.7	1.1	1.3	2.0	2.7*	2.7*	7.3 m	
	0 ft	■	7.3*	7.3*	7.3*	7.3*	4.6	5.5	8.8	13.0	3.1	3.7	5.7	8.2	2.4	2.9	4.4	6.0*	6.0*	24.0 ft	
	-1.5 m	●	3.9	4.5	7.0*	7.0*	2.1	2.4	4.0	5.5*	1.4	1.6	2.6	3.6	1.2	1.4	2.2	3.1	3.1	6.7 m	
	5 ft	■	8.6	9.9	15.4*	15.4*	4.6	5.3	8.8	12.1*	3.1	3.5	5.7	7.9	2.6	3.1	4.9	6.8	6.8	22.0 ft	

Equipment

STANDARD EQUIPMENT

Engine

Turbocharged, 4 stroke Volvo diesel engine with water cooling, direct injection and charged air cooler that meets EPA Tier 4 Final emission requirements

Intake air pre-heater

ECO-mode

Fuel filter and water separator

Fuel filler pump with automatic shut-off

Aluminium core radiator

Electric / Electronic control system

Contronics-computerized monitoring and diagnostic system

Adjustable automatic idling system

One-touch power boost

Adjustable monitor

Safety stop/start function and master electrical disconnect switch

Alternator, 120 A

Batteries, 2 x 12 V/100 Ah

CareTrack via GSM or satellite

Rear view camera with camera

Side view camera right hand side with camera

Superstructure

LED Rear lights

Centralized lubricating point for slew bearing and boom

Undercarriage

3 speeds: creep / offroad / road speed up to 35 km/h (31.7 mi/h)

Oscillating front axle $\pm 7^\circ$ with out mudguards/ 5° with mudguards

New machine tie-down points¹

2-circuit travel brakes

Maintenance free drive-shafts¹

Hydraulic system

Load sensing hydraulic system

Pressure relief system (servo accumulator)

9 inch single or twin tires

Hose rupture valve for boom and arm

Hydraulic long life oil ISO VG 46

Cab and interior

Volvo Care Cab with fixed roof hatch /ROPS

Cup holder

Door locks

Safety glass, light tinted

Floor mat

Horn

Large storage area

Pull-up type front window

Removable lower windshield

2 or 3 inch Retractable seat belt

Windshield wiper with washer and intermittent feature

Heater & air-conditioner, automatic

Hydraulic dampening cab mounts

Adjustable operator seat and joystick control console

Adjustable steering column

Hydraulic safety lock lever

Control joysticks, Proportional or L8 proportional

Bluetooth radio with USB port

Sun shield, front, roof & rear

Master ignition key

Multi function switch on LH Joystick

Digging equipment

Attachment points for extra hydraulics

4.85 m (15'11") 2-piece boom

Centralized lubrication point for arm and bucket

OPTIONAL EQUIPMENT

Engine

Diesel coolant heater with digital timer

Block heater, 120 V

Water separator with heater

Dust net

Tropical cooling

Electric / Electronic control system

Grapple bucket change over function

Joystick steering (Comfort Drive Control)

Multi-channel electric centre passage

Joystick Controlled Support (blade / outrigger function on LH joystick)

L8 can bus joysticks

Travel alarm

Extra work lights: (7 LED) Standard package

Extra work lights: (11 LED) luxury package with remote controlled welcome home lights

Cruise control

Anti-theft system

Tilting and rotating attachment preparation

Dig Assist 2D, In-Field Design, 3D for Trimble and Topcon, On-Board Weighing

Rotating beacon on cab and counterweight

Superstructure

License plate preparation

Undercarriage

Trailer Towing system

Rear parallel divided blade

Rear parallel standard blade

Rear inline outriggers

Front inline outriggers

Front divided blades

Front standard parallel blade

4 wheel steering with crab steering

9 inch twin tires with stone protection ring

9 inch twin tires without stoneprotection ring

9 inch singles tires

Grab holder

Axle mounted mudguards , Front and rear

Metal mudguards (stand on type)

Tool box, left hand side/right hand side

Drawer type Toolbox (120 kg / 265 lb)

Travel speed 20/30/35 km/h | 12.4/18.6/21.7 mi/h

Automatic digging brake

Hydraulic system

Holding valves on bucket

Boom float function

Boom suspension system

Hydraulic oil, biodegradable ISO VG 32

Hydraulic oil, biodegradable ISO VG 46

Hydraulic long life oil ISO VG 32

Hydraulic long life oil ISO VG 68

oil leak lines

auto connect SQ quick coupler preparation

Hydraulic equipment for:

- Hammer & shears

- Slope bucket/rotator

- Grab/clam shell

- Quick fit

- Flow control

- Flow & pressure control

OPTIONAL EQUIPMENT

Cab and interior

- Volvo Care Cab with openable PC roof hatch / ROPS
- Proportional control joystick
- L8 joystick
- Hydraulic proportional pedal for attachment control
- Falling object guard (FOG)
- Cab mounted falling object protective structures (FOPS)
- Rain shield, front
- Second generation Steelwrist tiltrotator preparation
- Sunlight protection, roof hatch (steel)
- Lower wiper
- Safety net for front window
- Volvo Smart View (a 360° camera system with 3 cameras)
- Ashtray
- Lighter
- Mechanical Fabric seat, with/or without heater
- Air suspension seat with heater and X isolator
- Luxury operator seat with aico and wide armrest

Digging equipment

- Dipper arms: 2.1m (6'11"), 2.4 m (7'10")

OPTIONAL EQUIPMENT

Hydraulic quick fit

- S50 & S60 system
- Universal system

Service

- Wheel chocks
- Tool kit, daily maintenance
- Automatic Greasing System

Attachments

- Buckets from 0.27 m³ (0.35 yd³) till 0.66 m³ (0.86 yd³), Tilt bucket
- X14 Steelwrist® tiltrotator

SELECTION OF VOLVO OPTIONAL EQUIPMENT

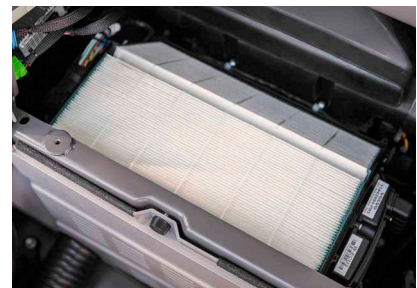
In-line outriggers with trailer hitch**4-wheel steering****Auto lubrication system****Choice of tires****Steel mudguards****HEPA filter**

Not all products are available in all markets. Under our policy of continuous improvement, we reserve the right to change specifications and design without prior notice. The illustrations do not necessarily show the standard version of the machine.

VOLVO

Volvo Construction Equipment

volvoce.com