

V O L V O



Volvo Wheel Loaders 24.1-33.1 t 304-380 hp

L150H, L180H, L220H

Volvo Construction Equipment



Smarter, stronger, faster

The new H-series L150, L180 and L220 may boast the same striking design as each of its forerunners, but these machines have been updated with the latest innovative technology, promoting greater productivity and fuel efficiency. Ready to tackle a range of applications, enjoy the same reliability and quality you'd expect from your Volvo wheel loader and more.

1954

The world's first wheel loader to feature a parallel lift arm system and attachment bracket with quick coupler – the H-10

1973

The first wheel loader with direct injected turbo engine – Volvo BM 1641

Volvo introduced the world's first truly low-emission diesel engines in construction equipment (1974)

1981

Volvo introduced the world's first automatic gear shifting system (Automatic Power Shift) and load sensing hydraulic technology

1988

Comfort Drive Control



Progress is in our DNA

Since introducing our first wheel loader, Volvo has continued to refine its concept for more than half a century. Over the years, we have revolutionized our machines, bringing customers unparalleled productivity and efficiency.

With you for the long run

As your trusted partner in production, Volvo is here to support you with the best equipment for the job. Boasting a comprehensive portfolio of attachments designed to complement your machines performance, as well as a range of services to boost your profitability, we'll help you tailor the perfect package to suit your business needs.

1990

Boom suspension system

Volvo patented Torque Parallel linkage (1991)

2009

Volvo sets the standard for the attachment bracket (ISO 23727)

2010

OptiShift
CareTrack

2016

Load Assist, powered by the award-winning Volvo Co-Pilot

2017

New generation OptiShift
Second generation load sensing hydraulics – Patent pending

Smarter operation

Primed for productivity, the innovative L150H, L180H and L220H loaders combine the latest Volvo technology, including second generation OptiShift, with power and upgraded features, resulting in up to 15% better fuel efficiency than the G-series.

Up to 15% greater fuel efficiency

Do more with less fuel, the H-series machine updates offer up to 15% greater fuel efficiency than the G-series. Contributing to the increase is the powerful engine, second generation OptiShift, attachment optimization and the new dry P-Brake, which eliminates drag losses.



Reverse By Braking

Extend the life of your machine's components and increase operator comfort with Reverse By Braking (RBB) – patented by Volvo. The braking function slows the machine when the operator wants to change direction, by reducing engine rpm and automatically applying the service brakes, reducing stress on the drivetrain.



Power up, fuel down

For short cycle times and high fuel efficiency, the H-series wheel loaders are fitted with a powerful Volvo engine – compliant with the latest emission regulations – delivering greater output and torque than the G-series.



Eco pedal

Save on machine wear and increase fuel efficiency with the eco pedal. Uniquely designed by Volvo, the eco pedal encourages economical operation, by applying a mechanical push-back force in response to excess use of the accelerator.





NEW GENERATION OPTISHIFT

For improved cycle times and reduced fuel consumption, customize the lock-up engagement of your machine, with new generation OptiShift. The improved technology integrates the Reverse By Braking function and the new torque converter with lock-up, creating a direct drive between the engine and transmission.

Made to move

Engineered for efficient work, the L150H, L180H and L220H are fitted with a new transmission and improved technology, resulting in up to 10% better productivity than the G-series.

Boost your productivity by up to 10%

For ultimate stability and high efficiency, the H-series wheel loaders have been upgraded with a new transmission, which works in harmony with the engine and axels. The new converter delivers increased torque output, resulting in better performance at low speeds. For faster acceleration and smooth operation, the steps between gears have been reduced.



Fast cycle times

Achieve shorter cycle times with next generation load sensing hydraulics, designed to enhance the responsiveness of attachments and improve the lifting and lowering speed of the boom.



Comfortably productive

Customize your machine and ensure precise control of hydraulic functions, with the choice of single or multi levers. To get the most out of each operation, select from three hydraulic modes, according to your preferred responsiveness.



Bucket leveling function

Take your productivity to the next level with the new bucket leveling function. Automatically return the bucket to level from both dump and curl positions, enhancing operator performance.



Load Assist

Optimize your load cycles with Load Assist, powered by Volvo Co-Pilot – the 10" in-cab display. Gain access to a set of smart apps and boost the efficiency of your operation. When installed, the rear-view camera and radar detect system are now integrated into the Volvo Co-Pilot.

On-Board Weighing

Make overloading, underloading, reweighing and waiting times a thing of the past with On-Board Weighing, providing real-time insight into the bucket's load. What's more, with the new Simple Mode, it has never been easier to start reaping the benefits of On-Board Weighing.



Operator Coaching

Operator Coaching helps to ensure operators are using their Volvo machine to its full potential. The intuitive app provides real-time guidance to operators, helping them understand how their actions influence machine productivity and efficiency, as well as identify areas for improvement or changes in their technique.



Tire Pressure Monitoring System

With the tire pressure monitoring app, you can check the condition of your tires from the comfort of the cab. Providing real-time information on tire pressure and temperature, the system saves time during machine inspections and can prolong tire lifetime.



Map

Get accurate machine positioning with Map, a clever app that allows operators to monitor on-site traffic in real-time. Not only does this give operators an improved orientation of the site they are working on, but it allows them to proactively adjust their driving behavior according to traffic conditions.



Fully loaded

Get the most out of your Volvo wheel loader with a range of purpose built attachments. Form one solid and reliable unit, with attachments that are ideally matched by size and design to your machine's parameters – including link-arm geometry, breakout and lifting forces. If we don't have the right attachment, Volvo can custom build one to your specific requirements.

Rehandling

Experience up to 5% greater productivity with a new range of Volvo Rehandling buckets. The redesigned buckets are easier to fill and minimize spillage, thanks to new convex sides and the improved spill guard. To prevent spillage and absorb shocks, opt for the Boom Suspension System, which automatically engages, depending on gear or speed selection.



Log handling

Designed for high lifting force and tilt out force, and offering maximum stability in log handling applications, select from a choice of general purpose grapples, sorting grapples and unloading grapples.



Slag handling

To protect you and your machine, and ensure durable performance in hot slag handling applications, Volvo offers a selection of specially-designed machine options and attachments.



Block handling

For high lifting force and maximum stability in block handling applications, choose from a range of robust Volvo attachments, including block forks, breaker tine and clearing rakes.





"Taking 27 tonne blocks from the quarry floor to the loading area is not a problem with the L220H."

Giuseppe Sanna, Director of Production,
MARMÍ DAINO REAL, Italy



TORQUE PARALLEL LINKAGE

For strength in demanding applications, Volvo's unique Torque Parallel (TP) linkage provides high breakout torque and ultimate parallel movement throughout the entire lifting range. The linkage offers stability during loading and carrying and allows easy filling of the buckets. For long lasting performance, the lifting arm has double sealing on each of the pins.

Strong and smart machines

Built with the operator in mind

- Adjustable seat
- Choice of three hydraulic modes
- Comfort Drive Control (option)
- Radar detect system (option)
- Remote-control door opener (option)
- Collision Mitigation System (option)

Up to 15% greater fuel efficiency

- Rimpull control
- New generation OptiShift
- Reverse By Braking
- Eco pedal
- Dry P-brake



Boost your productivity by up to 10%

- New load sensing hydraulics
- New transmission and gear ratio
- Bucket leveling function
- Load Assist, powered by Volvo Co-Pilot
- Choice of single or multi levers

Maximize your uptime

- 1000hr engine oil change interval
- Quicker hydraulic oil fill thanks to new mounted nipple
- Tilting cab, electronically-operated engine hood
- Brake wear indicators
- Outboard mounted brakes
- Replaceable breather filters

Fully loaded

- Unique Torque Parallel linkage
- Block handling
- Slag handling
- Log handling
- Rehandling – up to 5% greater productivity

Here to support you

- Genuine Volvo Parts
- Operator training
- ActiveCare



Built with the operator in mind

Built with the customer, for the customer, the L150H, L180H and L220H boast a range of features to enhance your operating experience. For increased productivity, the Volvo cab can be customized to your preference.

Visibility

To enhance visibility, the H-series wheel loaders can be equipped with a rear-view camera. Optimized by the radar detect system, which works with the camera to give a visual and audible alert to the operator of unseen on-coming objects. Orange handrails and steps have been placed on the machine, intended to stand out to the operators and maintenance staff.



Comfort Drive Control

To reduce operator fatigue and improve productivity, Comfort Drive Control can be optionally integrated into your machine. The smart function gives you the opportunity to steer the machine from a small lever – particularly effective for fast-paced truck loading operations.



Operator training

Increase productivity and reduce fuel consumption by learning how to operate your wheel loader in the most efficient way. Volvo offers operator training, which encompasses the best practices in the industry.



Collision Mitigation System

The Collision Mitigation System has been developed to support the safe operation of Volvo Wheel Loaders. The optional system assists operators while working in reverse by automatically applying the brakes when the machine approaches an obstacle, helping to reduce the risk or consequences of collisions and enhance jobsite safety.





"I'm very pleased that we decided to go for these machines."

Wayne Flew, Operator,
Albion Stone (United Kingdom)

THE OPERATOR'S CHOICE

Operate in comfort from the best cab on the market, the Volvo cab can be equipped with a new adjustable seat. Access the cab safely and effortlessly using the steps and open the door with ease, thanks to the optional remote-control opener.

Keep moving

Offering strength in demanding applications, the L150H, L180H and L220H are built to last. Maintain the life of your machine with simple serviceability and proactive dealer support.

Durable by design

Designed with durability in mind, the H-series wheel loaders are built with a strong frame structure, ideally-matched to Volvo powertrain. The hydraulically-driven cooling fan regulates component temperature and can be automatically reversed to permit self-cleaning of the cooling units. For long service life, the brakes are outboard mounted and the front and rear axles are cooled by the oil circulation.



ActiveCare

Keep your machine moving with ActiveCare. Volvo monitors machine health remotely, from our very own Uptime Center, helping to predict potential failures before they occur. This gives you more time to focus on your operation, helping to reduce unplanned downtime and minimize repair costs.



Here to support you

Maintain productivity and machine uptime with our range of readily available Genuine Volvo Parts, all backed by Volvo warranty. We're here to help you stay on track, offering flexible maintenance and repair plans.





"We have chosen Volvo machines based on quality, trust and service."

Gerard den Hartog, CEO,
Gebroeders Den Hartog (Netherlands)

INDUSTRY LEADING SERVICEABILITY

For simple serviceability, the Volvo cab can be tilted to either a 30° or 70° angle, and the engine hood is operated electronically. Stay one step ahead and check the condition of your brakes using the brake wear indicators, placed on the wheels. To prevent dirt and moisture from entering components, each has replaceable breather filters, located remotely.

Volvo L150H, L180H, L220H in detail

Engine

V-ACT Stage V 13 liter, 6-cylinder straight turbocharged diesel engine with 4 valves per cylinder, overhead camshaft and electronically controlled unit injectors. The engine has wet replaceable cylinder liners and replaceable valve guides and valve seats. The throttle applications is transmitted electrically from the throttle pedal or the optional hand throttle.

Air Cleaning: 3 stages.

Cooling system: Hydrostatic, electronically controlled fan and intercooler of the air-to-air type.

L150H

Engine	Volvo	D13J
Max. power at	r/min	1 300
ECE R120 net	kW	224
	hp	304
ISO 9249, SAE J1349 net	kW	223
	hp	303
Max. torque at	r/min	1 000
ECE R120 net	Nm	1 999
ISO 9249, SAE J1349 net	Nm	1 996
Economic working range	r/min	800 - 1 600
Displacement	l	128

L180H

Engine	Volvo	D13J
Max. power at	r/min	1 300 - 1 400
ECE R120 net	kW	251
	hp	341
ISO 9249, SAE J1349 net	kW	250
	hp	340
Max. torque at	r/min	1 000
ECE R120 net	Nm	2 071
ISO 9249, SAE J1349 net	Nm	2 065
Economic working range	r/min	800 - 1 600
Displacement	l	128

L220H

Engine	Volvo	D13J
Max. power at	r/min	1 300 - 1 400
ECE R120 net	kW	280
	hp	380
ISO 9249, SAE J1349 net	kW	279
	hp	379
Max. torque at	r/min	1 100
ECE R120 net	Nm	2 276
ISO 9249, SAE J1349 net	Nm	2 265
Economic working range	r/min	800 - 1 600
Displacement	l	128

L150H

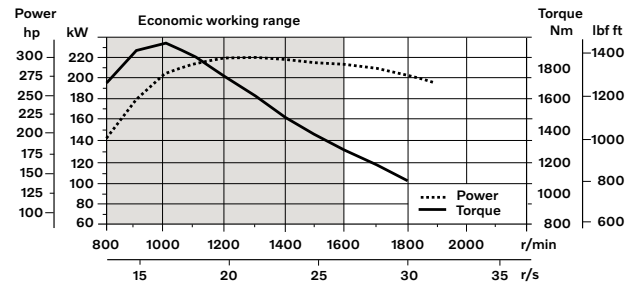

L180H

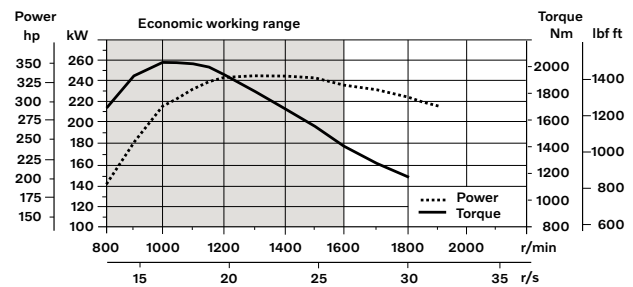

L220H

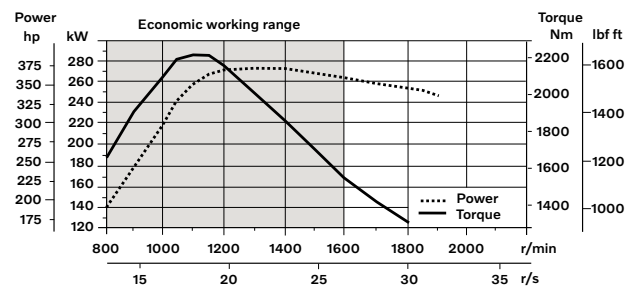

Drivetrain				
Torque converter: Single-stage.				
Transmission: Volvo countershaft transmission with single lever control. Fast and smooth shifting of gears with Pulse Width Modulation (PWM) valve. Torque converter with lockup.				
Transmission: Volvo Automatic Power Shift (APS) with fully automatic shifting 1-4 and mode selector with 4 different gear shifting programs, including AUTO. Also equipped with Rimpull control to avoid wheel spin and optimize bucket filling.				
Axles: Volvo fully floating drive shafts with planetary hub reductions and nodular iron axle housing. Fixed front axle and oscillating rear axle. 100% differential lock on the front axle. Optional: Limslip rear.				
	L150H	L180H	L220H	
Transmission	Volvo HTL 223	HTL 223	HTL 310	
Torque multiplication, stall ratio	2.09:1	2.09:1	2.02:1	
Maximum speed, forward/reverse				
1st gear	km/h	6.1	6.1	6.7 / 6.6
2nd gear	km/h	12.6	12.6	11.6 / 11.4
3rd gear	km/h	23.5	23.5	21.7 / 21.4
4th gear	km/h	38	38	36.5 / 36.1
Measured with tires		26.5 R25 L3	26.5 R25 L3	29.5 R25 L4
Front axle/rear axle		Volvo/AWB 40B/40C	Volvo/AWB 40B/40B	Volvo/AWB 50/41
Rear axle oscillation	± °	15	15	15
Ground clearance	mm	610	610	600
at oscillation	°	15	15	15

Electrical system				
Central warning system: Contronic electrical system with central warning light and buzzer for following functions: - Serious engine fault - Low steering system pressure - Over speed warning engine - Interruption in communication (computer fault) Central warning light and buzzer with the gear engaged for the following functions. - Low engine oil pressure - High engine oil temperature - High charge air temperature - Low coolant level - High coolant temperature - High crank case pressure - Low transmission oil pressure - High transmission oil temperature - Low brake pressure - Engaged parking brake - Fault on brake charging - Low hydraulic oil level - High hydraulic oil temperature - Overspeeding in engaged gear - High brake cooling oil temperature front and rear axles.				
	L150H	L180H	L220H	
Voltage	V	24	24	24
Batteries	V	2 x 12	2 x 12	2 x 12
Battery capacity	Ah	2 x 170	2 x 170	2 x 170
Cold cranking capacity, approx	A	1 000	1 000	1 000
Alternator rating	W/A	2 280/80	2 280/80	2 280/80
Starter motor output	kW	7	7	7

Brake system				
Service brake: Volvo dual-circuit system with nitrogen charged accumulators. Outboard mounted hydraulically operated, fully sealed oil circulation-cooled wet disc brakes. The operator can select automatic disengagement of the transmission when braking using Contronic.				
Parking brake: Dry disc brake. Applied by spring force, electro-hydraulic release with a switch on the instrument panel.				
Secondary brake: Dual brake circuits with rechargeable accumulators. One circuit or the parking brake fulfills all safety requirements.				
Standard: The brake system complies with the requirements of ISO 3450.				
	L150H	L180H	L220H	
Number of brake discs per wheel front/rear		1/1	1/1	2/1
Accumulators		2 x 1.0 + 3 x 0.5	2 x 1.0 + 1 x 0.5	2 x 1.0 + 1 x 0.5
Cab				
Instrumentation: All important information is centrally located in the operator's field of vision. Display for Contronic monitoring system.				
Heater and defroster: Heater coil with filtered fresh air and fan with auto and 11 speeds. Defroster vents for all window areas.				
Operator's seat: Operator's seat with adjustable suspension and retractable seatbelt. The seat is mounted on a bracket on the rear cab wall and floor. The forces from the retractable seatbelt are absorbed by the seat rails.				
Standard: The cab is tested and approved according to ROPS (ISO 3471), FOPS (ISO 3449). The cab meets with requirements according to ISO 6055 (Operator overhead protection - Industrial trucks) and SAE J386 ("Operator Restraint System"). Refrigerant of the type R134a is used when this machine is equipped with air conditioning. Contains fluorinated greenhouse gas R134a, Global Warming Potential 1.430 t CO2-eq				
	L150H	L180H	L220H	
Emergency exit: Use emergency hammer to break window				
Ventilation	m ³ /min	9	9	9
Heating capacity	kW	16	16	16
Air conditioning (optional)	kW	7.5	7.5	7.5
Lift Arm System				
Torque Parallel linkage (TP-linkage) with high breakout torque and parallel action throughout the entire lifting range.				
	L150H	L180H	L220H	
Lift cylinders		2	2	2
Cylinder bore	mm	160	180	190
Piston rod diameter	mm	90	90	90
Stroke	mm	784	788	768
Tilt cylinder		1	1	1
Cylinder bore	mm	220	240	250
Piston rod diameter	mm	110	120	120
Stroke	mm	452	480	455

Volvo L150H, L180H, L220H in detail

Hydraulic system

System supply: Two load-sensing axial piston pumps with variable displacement. The steering function always has priority.
Valves: Double-acting 2-spool valve. The main valve is electro operated.
Lift function: The valve has four positions; raise, hold, lower and floating position. Inductive/magnetic automatic boom kickout can be switched on and off and is adjustable to any position between maximum reach and full lifting height.
Tilt function: The valve has three functions including rollback, hold and dump. Inductive/magnetic automatic tilt can be adjusted to the desired bucket angle.
Cylinders: Double-acting cylinders for all functions.
Filter: Full flow filtration through 10 micron (absolute) filter cartridge.

		L150H	L180H	L220H
Working pressure maximum, pump 1 for working hydraulic system	MPa	29	29	29
Flow at engine speed	l/min	180	217	252
	MPa	10	10	10
Working pressure maximum, pump 2 for steering-, brake-, pilot- and working hydraulic system	MPa	31	31	31
Flow at engine speed	l/min	202	202	202
	MPa	10	10	10
Working pressure maximum, pump 3 for brake- and cooling fan system	MPa	25	25	25
Flow at engine speed	l/min	83	83	83
	MPa	10	10	10
Pilot system, working pressure	MPa	3.5	3.5	3.5
Cycle times				
Lift	s	5.9	6.4	6.8
Tilt	s	2	1.8	1.6
Lower, empty	s	3.7	3.3	3.2
Total cycle time	s	11.6	11.5	11.6

Steering System

Steering system: Load-sensing hydrostatic articulated steering.
System supply: The steering system has priority feed from a load-sensing axial piston pump with variable displacement.
Steering cylinders: Two double-acting cylinders.

		L150H	L180H	L220H
Steering cylinders		2	2	2
Cylinder bore	mm	100	100	100
Rod diameter	mm	60	60	60
Stroke	mm	390	525	525
Working pressure	MPa	21	21	21
Maximum flow	l/min	202	202	202
Maximum articulation	± °	37	37	37

Service Refill

Service accessibility: Large, easy-to-open hood covering whole engine department, electrically operated. Fluid filters and component breather air filters promote long service intervals. A quick-fit adapter on the hydraulic tank provides faster hydraulic oil fill. Possibility to monitor, log and analyze data to facilitate troubleshooting.

		L150H	L180H	L220H
Fuel tank	l	366	366	366
DEF/AdBlue® tank	l	31	31	31
Engine coolant	l	55	55	55
Hydraulic oil tank	l	156	156	226
Transmission oil	l	48	48	48
Engine oil	l	50	50	50
Axle oil front	l	46	46	77
Axle oil rear	l	55	55	71

Sound Level

		L150H	L180H	L220H
Sound pressure level in cab according to ISO 6396				
L _{pA}	dB	69	70	70
External sound level according to ISO 6395 and EU Noise Directive 2000/14/EC				
L _{WA}	dB	108	108	109

Specifications

Tires L150H, L180H: 26.5 R25 L3. Tires L220H: 29.5 R25 L3
Tire deflection: standard

		Standard boom			Long boom		
		L150H	L180H	L220H	L150H	L180H	L220H
B	mm	7 070	7 190	7 480	7 570	7 620	7 800
C	mm	3 550	3 550	3 700	3 550	3 550	3 700
D	mm	480	480	530	470	490	530
F	mm	3 580	3 580	3 730	3 570	3 590	3 730
G	mm	2 134	2 134	2 135	2 157	2 133	2 133
J	mm	3 920	4 060	4 230	4 490	4 560	4 600
K	mm	4 340	4 470	4 660	4 900	4 970	5 020
O	°	58	57	56	59	55	56
P _{max}	°	50	49	48	49	49	48
R	°	45	45	43	48	48	44
R ₁ *	°	48	48	47	53	53	49
S	°	66	71	65	61	63	63
T	mm	93	131	119	149	207	121
U	mm	520	570	600	640	660	680
X	mm	2 280	2 280	2 400	2 280	2 280	2 400
Y	mm	2 960	2 960	3 150	2 960	2 960	3 150
Z	mm	3 510	3 810	4 050	3 960	4 180	4 380
a ₂	mm	6 790	6 790	7 100	6 790	6 790	7 100
a ₃	mm	3 820	3 820	3 960	3 820	3 820	3 960
a ₄	±°	37	37	37	37	37	37

* Carry position SAE

Bucket: L150H: 4.0 m³ GP STE PT SEG
L180H: 4.6 m³ GP STE PT SEG
L220H: 5.2 m³ GP STE PT SEG

L150H Sales code: WLA80713
Operating weight (incl. logging cw 1 140 kg): 25 660 kg
Operating load: 7 700 kg

L180H Sales code: WLA80027
Operating weight (incl. logging cw 1 140 kg): 28 470 kg
Operating load: 8 710 kg

L220H Sales code: WLA80852
Operating weight (incl. logging cw 870 kg): 32 810 kg
Operating load: 10 080 kg

Where applicable, specifications and dimensions are according to ISO 7131, SAE J732, ISO 7546, SAE J742, ISO 14397, SAE J818.

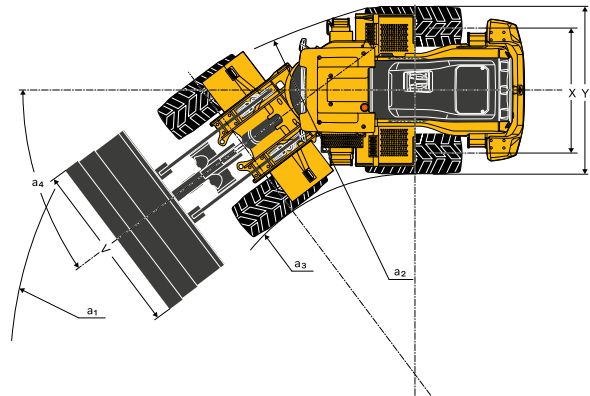
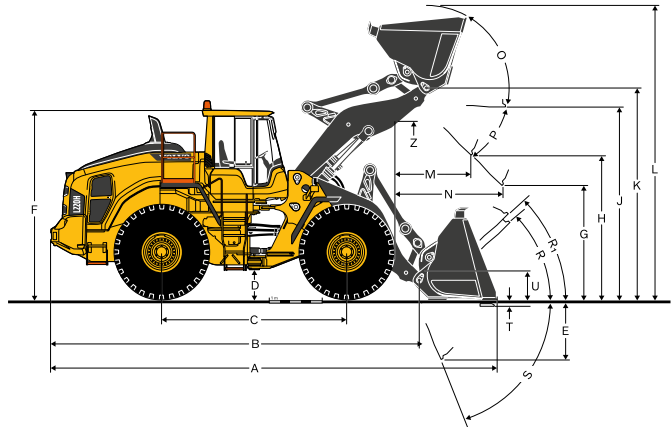





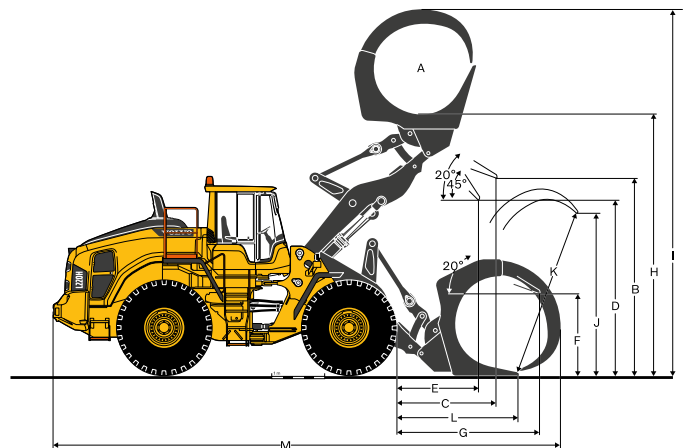





Tires L150H, L180H: 775/65 R29 L3 | Tires L220H: 875/65 R29 L4

		L150H	L180H	L220H
A	m ²	3.1	3.5	4
B	mm	3 660	3 870	3 920
C	mm	2 110	2 150	2 270
D	mm	2 960	3 150	3 160
E	mm	1 650	1 720	1 780
F	mm	1 630	1 700	1 640
G	mm	2 930	3 040	3 230
H	mm	4 990	5 170	5 350
I	mm	7 270	7 610	7 730
J	mm	3 080	3 370	3 620
K	mm	3 340	3 710	3 940
L	mm	2 290	2 410	2 630
M	mm	9 680	9 980	10 380



Volvo L150H Specifications

L150H

Tires 26.5 R25 L3		REHANDLING				GENERAL PURPOSE			ROCK***	LIGHT MATERIAL	LONG BOOM*
											
		4.0 m³ STE P BOE	4.4 m³ STE P BOE	4.8 m³ STE P BOE	5.2 m³ STE P BOE	4.0 m³ STE P T SEG	4.4 m³ STE P T SEG	4.5 m³ STE P T SEG	3.5 m³ SPN P T SEG	6.8 m³ LM P	4.0 m³ STE P T SEG
Volume, heaped ISO/SAE	m³	4.0	4.4	4.8	5.2	4.0	4.4	4.5	3.5	6.8	4.0
Volume at 110% fill factor	m³	4.4	4.8	5.3	5.7	4.4	4.8	5.0	3.9	7.5	4.4
Static tipping load, straight	kg	20 500	20 230	19 950	19 800	18 100	17 690	17 670	18 730	16 360	-3 550
at 35° turn	kg	18 320	18 050	17 780	17 630	16 190	15 780	15 760	16 730	14 520	-3 270
at full turn	kg	16 000	17 810	17 530	17 380	15 970	15 560	15 550	16 500	14 310	-3 230
Breakout force	kN	201.3	191.7	183.2	182.7	202	192	184	188.0	140.0	+9
A	mm	8 600	8 680	8 750	8 750	8 790	8 860	8 930	8 850	9 230	+520
E	mm	1 230	1 300	1 360	1 370	1 400	1 460	1 520	1 450	1 790	+10
H**)	mm	3 020	2 970	2 920	2 920	2 890	2 850	2 800	2 870	2 620	+570
L	mm	5 720	5 770	5 880	5 870	5 880	5 990	6 040	5 970	6 140	+570
M**)	mm	1 220	1 270	1 320	1 320	1 360	1 410	1 450	1 420	1 700	-20
N**)	mm	1 800	1 830	1 860	1 860	1 880	1 910	1 930	1 930	1 960	+450
V	mm	3 200	3 200	3 200	3 400	3 230	3 200	3 000	3 230	3 200	0
a ₁ clearance circle	mm	14 640	14 670	14 700	14 890	14 750	14 760	14 600	14 800	14 940	+340
Operating weight	kg	25 090	25 300	25 500	25 620	24 090	24 450	24 420	25 320	24 920	+410

*) Measured with 4.0 m³ GP STE P T SEG bucket Note: This only applies to genuine Volvo attachments.

**) Measured to the tip of the bucket teeth or bolt-on edge. Dump height to bucket edge measured at 45° dump angle. (Spade nose buckets at 42°.)

**) Measured with 26.5 R25 L5 tires

Bucket Selection Chart

The chosen bucket is determined by the density of the material and the expected bucket fill factor. The actual bucket volume is often larger than the rated capacity, due to the features of the TP linkage, including an open bucket design, good rollback angles in all positions and good bucket filling performance. The example represents a standard boom configuration. Example: Sand and gravel. Fill factor ~ 105%. Density 1.6 t/m³. Result: The 4.0 m³ bucket carries 4.2 m³. For optimum stability always consult the bucket selection chart.

Material	Bucket fill, %	Material density, t/m³	ISO/SAE bucket volume, m³	Actual volume, m³
Earth/Clay	~ 110	~ 1.6 ~ 1.5	4.0 4.4	~ 4.4 ~ 4.8
Sand/Gravel	~ 105	~ 1.6 ~ 1.5	4.0 4.4	~ 4.2 ~ 4.6
Aggregate	~ 100	~ 1.8 ~ 1.7 ~ 1.5	4.4 4.8 5.2	~ 4.4 ~ 4.8 ~ 5.2
Rock	≤ 100	~ 1.7	3.5	~ 3.5

The size of rock buckets is optimized for optimal penetration and filling capability rather than the density of the material.

Type of boom	Type of bucket	ISO/SAE Bucket volume	L150H Material density: (t/m³)						
			0,8	1,0	1,2	1,4	1,6	1,8	2,0
Standard boom	Rehandl* ing	4,4 m³						4,6	4,4
		4,8 m³					5,0	4,8	
		5,2 m³				5,5	5,2		
	General purpose	4,0 m³					4,4	4,0	
4,4 m³					4,8	4,4			
Rock	3,5 m³						3,5	3,3	
	Light material	6,8 m³	6,8						
Long boom	Rehandl* ing	4,0 m³					4,2	4,0	
		4,4 m³				4,6	4,4		
	General purpose	3,7 m³				4,1	3,7		
		Rock	3,5 m³					3,5	3,3
Light material	6,8 m³	6,8							

How to read bucket fill factor

* Including counterweight

Supplemental Operating Data

Tires 26.5 R25 L3		Standard boom			Long boom		
		26.5 R25 L4	26.5 R25 L5	775/65 R29 L3	26.5 R25 L4	26.5 R25 L5	775/65 R29 L3
Width over tires	mm	+5	+30	+180	+5	+30	+180
Ground clearance	mm	+18	+30	+10	+18	+30	+10
Tipping load, full turn	kg	+250	+760	+590	+220	+640	+500
Operating weight	kg	+400	+1 060	+760	+400	+1 050	+750

Volvo L180H Specifications

L180H

Tires 26.5 R25 L3		REHANDLING				GENERAL PURPOSE			ROCK***	LIGHT MATERIAL	LONG BOOM*
		4.8 m³ STE P BOE	5.2 m³ STE P BOE	5.5 m³ STE P BOE	5.8 m³ STE P BOE	4.4 m³ STE P T SEG	4.6 m³ STE P T SEG	4.8 m³ STE P T SEG	4.2 m³ SPN P T SEG	7.8 m³ LM P	4.6 m³ STE P T SEG
Volume, heaped ISO/SAE	m3	4.8	5.2	5.5	5.8	4.4	4.6	4.8	4.2	7.8	4.6
Volume at 110% fill factor	m3	5.3	5.7	6.1	6.4	4.8	5.1	5.3	4.6	8.6	5.1
Static tipping load, straight	kg	23 670	23 520	23 350	23 210	21 540	21 560	21 360	22 250	20 430	-3 820
at 35° turn	kg	21 010	20 860	20 700	20 570	19 140	19 150	18 960	19 750	18 070	-3 480
at full turn	kg	18 900	20 560	20 390	20 260	18 860	18 880	18 690	19 470	17 800	-3 450
Breakout force	kN	236	224.2	216.2	210.0	236.0	236.0	226.4	212.6	173.5	+3.9
A	mm	8 890	8 890	8 960	9 010	9 000	9 000	9 070	9 140	9 360	+470
E	mm	1 430	1 430	1 490	1 540	1 530	1 530	1 590	1 650	1 860	+20
H**)	mm	3 060	3 050	3 010	2 970	2 990	2 990	2 940	2 910	2 690	+500
L	mm	6 010	6 010	6 040	6 110	6 130	6 170	6 180	6 320	6 300	+500
M**)	mm	1 330	1 330	1 370	1 410	1 420	1 420	1 460	1 520	1 610	+20
N**)	mm	1 960	1 960	1 990	2 000	2 020	2 020	2 040	2 080	2 050	+410
V	mm	3 200	3 400	3 400	3 400	3 200	3 200	3 200	3 230	3 400	0
a1 clearance circle	mm	14 800	14 990	15 010	15 040	14 850	14 850	14 880	14 960	15 220	+350
Operating weight	kg	28 070	28 190	28 290	28 360	27 020	27 060	27 120	28 440	27 470	+270

*) Measured with 4.6 m3 GP STE P T SEG bucket Note: This only applies to genuine Volvo attachments.

**) Measured to the tip of the bucket teeth or bolt-on edge. Dump height to bucket edge measured at 45° dump angle. (Spade nose buckets at 42°.)

***) Measured with 26.5 R25 L5 tires

Bucket Selection Chart

The chosen bucket is determined by the density of the material and the expected bucket fill factor. The actual bucket volume is often larger than the rated capacity, due to the features of the TP linkage, including an open bucket design, good rollback angles in all positions and good bucket filling performance. The example represents a standard boom configuration. Example: Sand and gravel. Fill factor ~ 105%. Density 1.6 t/m³. Result: The 4.6 m³ bucket carries 4.8 m³. For optimum stability always consult the bucket selection chart.

Material	Bucket fill, %		Material density, t/m³	ISO/SAE bucket volume, m³	Actual volume, m³
Earth/Clay	~ 110		~ 1.7	4.4	~ 4.8
			~ 1.6	4.6	~ 5.1
			~ 1.5	4.8	~ 5.3
Sand/Gravel	~ 105		~ 1.7	4.4	~ 4.6
			~ 1.6	4.6	~ 4.8
			~ 1.5	4.8	~ 5.1
Aggregate	~ 100		~ 1.8	5.2	~ 5.2
			~ 1.7	5.5	~ 5.5
			~ 1.6	5.8	~ 5.8
Rock	≤100		~ 1.7	4.3	~ 4.3

The size of rock buckets is optimized for optimal penetration and filling capability rather than the density of the material.

Type of boom	Type of bucket	ISO/SAE Bucket volume	Material density: (t/m³)							
			L180H							
			0,8	1,0	1,2	1,4	1,6	1,8	2,0	
Standard boom	Rehandling*	5,2 m³						5,5	5,2	
		5,5 m³					5,8	5,5		
		5,8 m³			6,1	5,8				
	General purpose	4,4 m³						4,8	4,4	
		4,6 m³					5,1	4,6		
		4,8 m³			5,3	4,8				
Rock	4,2 m³						4,2	4,0		
Light material	7,8 m³	7,8								
Long boom	Rehandling*	4,8 m³					5,0	4,8		
		5,2 m³			5,5	5,2				
	General purpose	4,4 m³				4,8	4,4			
		4,2 m³						4,2	4,0	
Light material	7,8 m³	7,8								

How to read bucket fill factor











* Including counterweight

Supplemental Operating Data

Tires 26.5 R25 L3		Standard boom			Long boom		
		26.5 R25 L4	26.5 R25 L5	775/65 R29 L3	26.5 R25 L4	26.5 R25 L5	775/65 R29 L3
Width over tires	mm	+5	+30	+130	+5	+30	+130
Ground clearance	mm	+18	+40	+10	+18	+40	+10
Tipping load, full turn	kg	+280	+770	+600	+250	+760	+530
Operating weight	kg	+400	+1 050	+920	+400	+1 050	+1 120

Volvo L220H Specifications

L220H

Tires 29.5 R25 L3	REHANDLING				GENERAL PURPOSE			ROCK***	LIGHT MATERIAL	LONG BOOM*	
											
	5.6 m³ STE P BOE	5.9 m³ STE P BOE	6.3 m³ STE P BOE	4.9 m³ STE P T SEG	5.2 m³ STE P T SEG	5.6 m³ STE P T SEG	4.5 m³ SPN P T SEG	5.0 m³ SPN P T SEG	8.2 m³ LM P	5.2 m³ STE P T SEG	
Volume, heaped ISO/SAE	m³	5.6	5.9	6.3	4.9	5.2	5.6	4.5	5.0	8.2	5.2
Volume at 110% fill factor	m³	6.2	6.5	6.9	5.4	5.7	6.2	5.0	5.5	9.0	5.7
Static tipping load, straight	kg	25 270	25 140	24 960	23 960	23 900	23 600	24 900	23 770	22 820	-2 890
at 35° turn	kg	22 420	22 290	22 120	21 280	21 220	20 940	22 150	21 090	20 190	-2 650
at full turn	kg	22 090	21 970	21 800	20 980	20 910	20 630	21 840	20 780	19 890	-2 620
Breakout force	kN	228.9	223.1	215.0	255.9	244.5	229.0	211.5	196.5	190.8	+3.4
A	mm	9 270	9 310	9 380	9 310	9 350	9 460	9 580	9 730	9 580	+310
E	mm	1 470	1 510	1 570	1 510	1 540	1 640	1 730	1 860	1 750	-30
H**)	mm	3 160	3 130	3 080	3 130	3 110	3 040	3 030	2 930	2 910	+370
L	mm	6 260	6 290	6 370	6 370	6 440	6 440	6 450	6 510	6 450	+360
M**)	mm	1 400	1 440	1 480	1 430	1 470	1 560	1 700	1 800	1 610	-30
N**)	mm	2 100	2 120	2 150	2 120	2 160	2 200	2 250	2 300	2 180	+270
V	mm	3 400	3 400	3 400	3 430	3 400	3 400	3 430	3 430	3 700	0
a ₁ clearance circle	mm	15 570	15 590	15 620	15 610	15 610	15 670	15 770	15 850	16 020	+260
Operating weight	kg	31 950	32 020	32 130	31 160	31 190	31 260	32 710	33 130	31 660	+380

*) Measured with 5.2 m³ GP STE P T SEG bucket Note: This only applies to genuine Volvo attachments.

**) Measured to the tip of the bucket teeth or bolt-on edge. Dump height to bucket edge measured at 45° dump angle. (Spade nose buckets at 42°.)

**) Measured with 29.5 R25 L5 tires

Bucket Selection Chart

The chosen bucket is determined by the density of the material and the expected bucket fill factor. The actual bucket volume is often larger than the rated capacity, due to the features of the TP linkage, including an open bucket design, good rollback angles in all positions and good bucket filling performance. The example represents a standard boom configuration. Example: Sand and gravel. Fill factor ~ 105%. Density 1.6 t/m³. Result: The 5.2 m³ bucket carries 5.5 m³. For optimum stability always consult the bucket selection chart.

Material	Bucket fill, %	Material density, t/m³	ISO/SAE bucket volume, m³	Actual volume, m³
Earth/Clay	~ 110	~ 1.6	4.9	~ 5.4
		~ 1.5	5.2	~ 5.7
		~ 1.4	5.4	~ 5.9
Sand/Gravel	~ 105	~ 1.7	4.9	~ 5.1
		~ 1.6	5.2	~ 5.5
		~ 1.5	5.4	~ 5.7
Aggregate	~ 100	~ 1.8	5.6	~ 5.6
		~ 1.7	5.9	~ 5.9
		~ 1.6	6.3	~ 6.3
Rock	≤100	~ 1.7	4.5	~ 4.5

The size of rock buckets is optimized for optimal penetration and filling capability rather than the density of the material.

Type of boom	Type of bucket	ISO/SAE Bucket volume	L220H Material density: (t/m³)							
			0,8	1,0	1,2	1,4	1,6	1,8	2,0	
Standard boom	Rehandl*ing	5,6 m³							5,9	5,6
		5,9 m³						6,2	5,9	
		6,3 m³				6,6		6,3		
	General purpose	4,9 m³						5,4	4,9	
5,2 m³					5,7		5,2			
5,6 m³				6,2		5,6				
Rock	4,5 m³							4,5	4,3	
	5,0 m³						5,0	5,3		
Light material	8,2 m³	8,2								
	Long boom	Rehandl*ing	5,6 m³						5,9	5,6
5,9 m³						6,2		5,9		
General purpose		4,9 m³						5,4	4,9	
		4,5 m³						4,5	4,3	
Light material	8,2 m³	8,2								

How to read bucket fill factor

* Including counterweight

Supplemental Operating Data

Tires 29.5 R25 L4	Standard boom			Long boom			
	29.5 R25 L3	29.5 R25 L5	875/65 R29 L4	29.5 R25 L3	29.5 R25 L5	875/65 R29 L4	
Width over tires	mm	-20	+35	+95	-20	+35	+95
Ground clearance	mm	±0	+40	-10	±0	+40	-20
Tipping load, full turn	kg	-100	+1 010	+180	-90	+930	+180
Operating weight	kg	-80	+1 490	+650	-80	+1 500	+650

Equipment

STANDARD EQUIPMENT			
	L150H	L180H	L220H
Engine			
Exhaust after-treatment system	•	•	•
Two stage air cleaner, pre-cleaner, primary and secondary filter	•	•	•
Preheating of induction air	•	•	•
Fuel pre-filter with water trap	•	•	•
Fuel filter	•	•	•
Crankcase breather oil trap	•	•	•
Exterior radiator air intake protection	•	•	•
Drivetrain			
Automatic Power Shift	•	•	•
Fully automatic gearshifting, 1-4	•	•	•
PWM-controlled gearshifting	•	•	•
Forward and reverse switch by hydraulic lever console	•	•	•
Rimpull control	•	•	•
Indicator glass for transmission oil level	•	•	•
Differentials: Front, 100% hydraulic diff lock. Rear, conventional.	•	•	•
Optishift with Lock-up, RBB	•	•	•
Lock-up first gear	•	•	•
Electrical system			
24 V, pre-wired for optional accessories	•	•	•
Alternator 24V/80A/2280W	•	•	•
Battery disconnect switch	•	•	•
Fuel gauge	•	•	•
Hour meter	•	•	•
Electric horn	•	•	•
Instrument cluster:			
Fuel level			
Diesel Exhaust Fluid/AdBlue level	•	•	•
Transmission temperature			
Coolant temperature			
Instrument lighting			
Lighting:			
Twin halogen front headlights with high and low beams			
Parking lights	•	•	•
Double brake and tail lights			
Turn signals with flashing hazard light function			
Halogen work lights (2 front and 2 rear)			

STANDARD EQUIPMENT			
	L150H	L180H	L220H
Contronic monitoring system			
Monitoring and logging of machine data	•	•	•
Contronic display	•	•	•
Fuel consumption	•	•	•
Diesel Exhaust Fluid/AdBlue consumption	•	•	•
Ambient temperature	•	•	•
Clock	•	•	•
Test function for warning and indicator lights	•	•	•
Brake test	•	•	•
Test function, sound level at max fan speed	•	•	•
Warning and indicator lights:			
Battery charging	•	•	•
Parking brake			
Warning and display message:			
Regeneration			
Engine coolant temperature			
Charge-air temperature			
Engine oil temperature			
Engine oil pressure			
Transmission oil temperature			
Transmission oil pressure			
Hydraulic oil temperature	•	•	•
Brake pressure			
Parking brake applied			
Brake charging			
Overspeed at direction change			
Axle oil temperature			
Steering pressure			
Crankcase pressure			
Attachment lock open			
Safety Belt Warning			
Level warnings:			
Fuel level			
Diesel Exhaust Fluid/AdBlue level			
Engine oil level	•	•	•
Engine coolant level			
Transmission oil level			
Hydraulic oil level			
Washer fluid level			
Engine torque reduction in case of malfunction indication:			
High engine coolant temperature	•	•	•
High engine oil temperature			
Low engine oil pressure			
High crankcase pressure			
High charge-air temperature			
Engine shutdown to idle in case of malfunction indication:			
High transmission oil temperature	•	•	•
Slip in transmission clutches			
Keypad, background lit	•	•	•
Start interlock when gear is engaged	•	•	•

Equipment

STANDARD EQUIPMENT			
	L150H	L180H	L220H
Hydraulic system			
Main valve, double acting 2-spool with hydraulic pilots	•	•	•
Variable displacement axial piston pumps (3) for:			
1 Working hydraulics, Pilot hydraulics and Brake system	•	•	•
2 Working hydraulics, Pilot hydraulics, Steering and Brake system			
3 Cooling fan and Brake system			
Electro-hydraulic servo controls	•	•	•
Electronic hydraulic lever lock	•	•	•
Automatic boom kick-out	•	•	•
Automatic bucket positioner	•	•	•
Double-acting hydraulic cylinders	•	•	•
Indicator glass for hydraulic oil level	•	•	•
Hydraulic oil cooler	•	•	•
Brake system			
Dual brake circuits	•	•	•
Dual brake pedals	•	•	•
Secondary brake system	•	•	•
Parking brake, electro-hydraulic	•	•	•
Brake wear indicators	•	•	•
Cab			
ROPS (ISO 3471), FOPS (ISO 3449)	•	•	•
Single key kit door/start	•	•	•
Acoustic inner lining	•	•	•
Cigarette lighter, 24 V power outlet	•	•	•
Lockable door	•	•	•
Cab heating with fresh air inlet and defroster	•	•	•
Fresh air inlet with two filters	•	•	•
Automatic heat control	•	•	•
Floor mat	•	•	•
Dual interior lights	•	•	•
Interior rear-view mirrors	•	•	•
Dual exterior rear-view mirrors	•	•	•
Sliding window, right side	•	•	•
Tinted windshield glass	•	•	•
Retractable seatbelt (SAE J386)	•	•	•
Adjustable steering wheel	•	•	•
Storage compartment	•	•	•
Document pocket	•	•	•
Sun visor	•	•	•
Beverage holder	•	•	•
Windshield washer front and rear	•	•	•
Windshield wipers front and rear	•	•	•
Interval function for front and rear wipers	•	•	•

STANDARD EQUIPMENT			
	L150H	L180H	L220H
Service and maintenance			
Engine oil remote drain and fill	•	•	•
Transmission oil remote drain and fill	•	•	•
Lubrication manifolds, ground accessible	•	•	•
Pressure check connections: transmission and hydraulic, quick-connects	•	•	•
Quick-fit hydraulic oil fill	•	•	•
Tool box, lockable	•	•	•
External equipment			
Orange hand rails	•	•	•
Fenders, front and rear	•	•	•
Viscous cab mounts	•	•	•
Rubber engine and transmission mounts	•	•	•
Frame, joint lock	•	•	•
Vandalism lock prepared for			
Engine compartment	•	•	•
Radiator grille			
Lifting eyes	•	•	•
Tie-down eyes	•	•	•
Fabricated counterweight	•	•	•
Counterweight, pre-drilled for optional guards	•	•	•

OPTIONAL EQUIPMENT

	L150H	L180H	L220H
Engine			
Air pre-cleaner, cyclone type	•	•	•
Air pre-cleaner, oil-bath type	•	•	•
Air pre-cleaner, turbo type	•	•	•
Engine auto shutdown	•	•	•
Engine delayed shutdown	•	•	•
Engine block heater 230V/110V	•	•	•
Fuel fill strainer	•	•	•
Fuel heater	•	•	•
Hand throttle control	•	•	•
Max. fan speed, hot climate	•	•	•
Radiator, corrosion-protected	•	•	•
Reversible cooling fan	•	•	•
Reversible cooling fan and axle oil cooler	•	•	•
Tires			
26.5 R25	•	•	–
775/65 R29	•	•	–
29.5 R25	–	–	•
875/65 R29	–	–	•
Drivetrain			
Diff lock front 100%, Limited Slip rear	•	•	•
Speed limiter	•	•	•
Wheel/axle seal guards	•	•	•
Electrical system			
Anti-theft device	•	•	•
Emergency stop	•	•	•
Locking device, Tag out Lock out	•	•	•
Headlights, assym. left	•	•	•
License plate holder, lighting	•	•	•
Rear vision system, colour LCD monitor in the cab	•	•	•
Rear view mirrors, Long arm	•	•	•
Rear view mirrors, adjustable, el.heated, Long arm	•	•	•
Reduced function working lights, reverse gear activated	•	•	•
Reverse alarm, audible	•	•	•
Reverse alarm, white noise	•	•	•
Reverse warning light, strobe lighting	•	•	•
Seatbelt indicator, external	•	•	•
Shortened headlight support brackets	•	•	•
Side marker lamps	•	•	–
Warning beacon LED	•	•	•
Warning beacon LED automatic	•	•	•
LED Head Light	•	•	•
LED tail light	•	•	•
LED working lights, attachments	•	•	•
LED working lights on cab, front and rear	•	•	•
LED working lights on cab, front, 2 alt. 4 LED lamps	•	•	•
LED working lights on cab, rear, 2 alt. 4 LED lamps	•	•	•
LED working lights, rear in grille, 2 LED lamps	•	•	•
LED working lights, front above head lamps, 2 LED lamps	•	•	•
LED work lights, side on cab, 4 LED lamps	•	•	•
LED light packages	•	•	•
Working lights halogen, attachments	•	•	•
Working lights on cab halogen, front and rear	•	•	•
Working lights on cab halogen, rear	•	•	•
Electrical distribution unit 24 volt	•	•	•
Alternator 120 amp, heavy-duty	•	•	•
Radar detect system	•	•	•
Forward camera, colour	•	•	•
Parking brake alarm, audible for air susp seats	•	•	•
Jump start connector, NATO-Type	•	•	•
Max Boom height	•	•	•
Can Bus Interface	•	•	•
Delayed Engine Shutdown	•	•	•
Co Pilot available	•	•	•
Rearview camera in Co pilot	•	•	•
OnBoard Weighing	•	•	•
Tire pressure monitoring	•	•	•
MAP	•	•	•

OPTIONAL EQUIPMENT

	L150H	L180H	L220H
Hydraulic system			
Boom suspension system	•	•	•
Separate attachment locking	•	•	•
Arctic kit, for 3rd function	•	•	•
Boom cylinder hose and tube guards	•	•	•
Hydraulic fluid, biodegradable, Volvo	•	•	•
Hydraulic fluid, fire-resistant	•	•	•
Hydraulic fluid, for hot climate	•	•	•
Hydraulic 3rd function	•	•	•
hydraulic 3rd-4th function	•	•	•
Single lever control, hydraulics 2 functions	•	•	•
Single lever control, hydraulics 3 functions	•	•	•
Single lever control, hydraulics 4 functions	•	•	•
Brake system			
Oil cooler and filter front & rear axle	•	•	•
Stainless steel, brake lines	•	•	–
Cab			
Anchorage for Operator's manual	•	•	•
Automatic Climate Control, ACC	•	•	•
ACC control panel, with Fahrenheit scale	•	•	•
Asbestos dust protection filter	•	•	•
Ashtray	•	•	•
Cab air pre-cleaner, cyclone type	•	•	•
Carbon filter	•	•	•
Cover plate, under cab	•	•	•
Lunch box holder	•	•	•
Volvo Armrest, operator's seat, left	•	•	•
Operator's seat, Volvo air susp, heavy-duty, high back, heated	•	•	•
Operator's seat, (air seat std) 2-point seat belt	•	•	•
Operator's seat, (air seat std) 3-point seat belt	•	•	•
Operator's seat, Premium Comfort ISRI	•	•	•
Operator's seat, Premium Comfort ISRI 3-point seat belt	•	•	•
Radio installation kit incl. 12 volt outlet, left side	•	•	•
Radio installation kit incl. 12 volt outlet, right side	•	•	•
Radio (with AUX, Bluetooth and USB connection)	•	•	•
DAB Radio	•	•	•
Subwoofer	•	•	•
Steering wheel knob	•	•	•
Sun blinds, rear windows	•	•	•
Sun blinds, side windows	•	•	•
Timer cab heating	•	•	•
Window, sliding, door	•	•	•
Universal door/ignition key	•	•	•
Remote door opener	•	•	•
Forward view mirror	•	•	•
Cab heater power outlet 240V	•	•	•
Cab, Hot applications. Roof, steel	•	•	•
Fire extinguisher cab	•	•	•
Outside steel protection cab	•	•	•
Rear view mirrors long arm, cab	•	•	•
Reinforced windshield, flat	•	•	•

Equipment

OPTIONAL EQUIPMENT			
	L150H	L180H	L220H
Service and maintenance			
Automatic lubrication system	•	•	•
Automatic lubrication system for long boom	•	•	•
Grease nipple guards	•	•	•
Oil sampling valve	•	•	•
Quick engine oil change	•	•	•
Refill pump for grease to lube system	•	•	•
Tool kit	•	•	•
Wheel nut wrench kit	•	•	•
CareTrack, GSM, GSM/Satellite	•	•	•
Telematics, Subscription	•	•	•
Belly guard front	•	•	•
Belly guard rear	•	•	•
Cover plate, heavy-duty, front frame	•	•	•
Cover plate, rear frame	•	•	•
Cab roof, heavy-duty	•	•	•
Guards for front headlights	•	•	•
Guards for radiator grill	•	•	•
Guards for tail lights	•	•	•
Windows, side and rear guards	•	•	•
Windshield guard	•	•	•
Corrosion protection, painting of machine	•	•	•
Corrosion protection, painting of attachment bracket	•	•	–
Option for machines without dinitrol	•	•	•
Bucket Teeth protection	•	•	–
External equipment			
Cab ladder, rubber-suspended	•	•	•
Escape Ladder, left fender	•	•	•
Handles on counterweight	•	•	•
Deleted front mudguards	•	•	•
Fire suppression system	•	•	•
Mudguards, full cover, front and rear for 80-series tires	•	•	•
Mudguards, full cover, front and rear for 65-series tires	•	•	•
Long boom	•	•	•
Tow hitch	•	•	•

OPTIONAL EQUIPMENT			
	L150H	L180H	L220H
Other equipment			
CE-marking	•	•	•
Comfort Drive Control (CDC)	•	•	•
Counterweight, logging	•	•	•
Counterweight, signal painted, chevrons	•	•	•
Secondary steering with automatic test function	•	•	•
Sound decal, EU	•	•	•
Sound decal, USA	•	•	•
Reflecting stickers (decals), machine contour	•	•	•
Reflecting stickers (stripes), machine contour Cab	•	•	•
Noise reduction kit, exterior	•	•	•
Sign, 50 km/h	•	–	–
Attachments			
Buckets:	•	•	•
Rock straight or spade nose	•	•	•
General purpose	•	•	•
Re-handling	•	•	•
Side-dump	•	•	•
Light material	•	•	•
Wear parts:	•	•	•
Bolt-on and weld-on bucket teeth	•	•	•
Segments	•	•	•
Cutting edge in three sections, bolt-on	•	•	•
Fork equipment	•	•	•
Material handling arm	•	•	•
Log grapples	•	•	•

SELECTION OF VOLVO OPTIONAL EQUIPMENT

Additional auxiliary hydraulics



Central lubrication system



Fire suppression system



External axle oil cooling



LED light packages



Long boom



Not all products are available in all markets. Under our policy of continuous improvement, we reserve the right to change specifications and design without prior notice. The illustrations do not necessarily show the standard version of the machine.

V O L V O